



***ENJOY YOUR SMART FIRE***

Manage your biomass  
heating system  
**anywhere, anytime**

info@robinwood-gmbh.de  
robinwood-gmbh.de



MONTAGEANLEITUNG  
INSTALLATION INSTRUCTIONS  
ISTRUZIONI PER L'INSTALLAZIONE  
INSTRUCCIONES PARA LA INSTALACIÓN  
INSTRUCTIONS D'INSTALLATION

DE  
EN  
IT  
ES  
FR

SYSTEMSTRUKTUR	2
LOKALE VERBINDUNG UND FERNVERBINDUNG	3
TECHNISCHE DATEN	4
TASTEN UND LED	5
INSTALLATION	6
NEUE SMARTFIREModule KONFIGURATION	7
VERBINDUNG AN EIN BEREITS KONFIGURIERTES SMARTFIREModule	10
HOMEPAGE	11
SMART FIRE EINSTELLEN	14
SMART FIRE VERWALTEN	15
CHRONO UND SMART FIRE FUNKTION	16
GRAFIKANSICHT	21
BILDSCHIRMSEITE INFORMATION	22
BILDSCHIRMSEITE MENÜ	23



Die Struktur besteht aus 3 Makro-Systemen:

1. **SMARTFIREModule:** Hardware-Gerät, welches die SMART FIRE Steuereinheit mit dem lokalen WLAN-Router verbindet;
2. **SERVER CLOUD:** Webserver-Infrastruktur, die Datenspeicherung ermöglicht und als Sternpunkt der Fernkommunikation dient;
3. **SMART FIRE:** Smartphone-App im Google Play Store und im Apple Store kostenlos erhältlich und ermöglicht dem Nutzer Zugriff auf das Heizsystem.

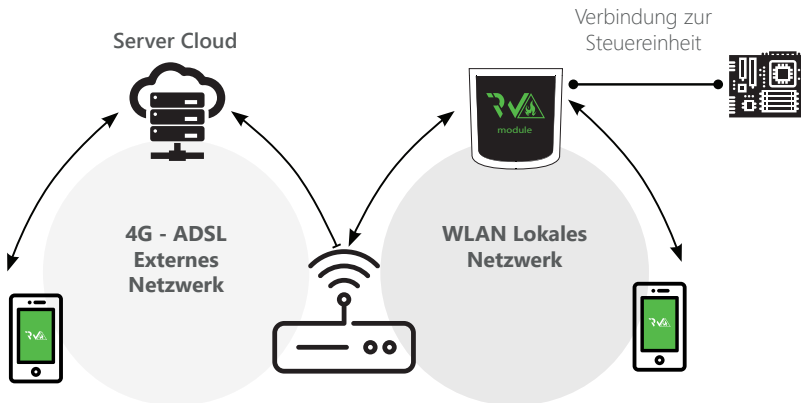



## Lokale Verbindung

Das SMARTFIREModule und die App müssen an demselben WLAN-Netzwerk angeschlossen sein, damit sie über das WLAN-Heimnetzwerk miteinander verbunden werden.



## Fernverbindung

Benutzt der Nutzer die App, wenn er nicht zu Hause ist, spricht man von einer Fernverbindung. In diesem Fall nutzt die App die Datenabdeckung von Ihrem Smartphone und der Cloud Server erlaubt die Triangulation des Signals, um das Modul aus der Ferne zu steuern. Die Zeiten der Fernverbindung können je nach Datentransfer, Netzwerkverbindung und Transfer zum Server variieren. Unter den schlechtesten Bedingungen, können sich die Verbindungszeiten bis zu 5 Minuten verzögern.

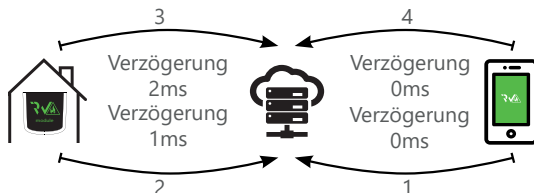

Die Fernverbindung können Sie erst nutzen, wenn Sie sich auf dem Cloud Server registriert haben (siehe S. ? NEUE SMARTFIREModule KONFIGURATION).



Kommunikationsanschlüsse	RS232 RS485
Stromversorgung	5V
Gehäuse	Housing in ABS
Temperaturbereich	-20° ÷ 60°
Fixierung	Blechschauben 3,5 mm

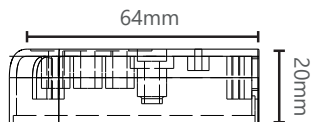
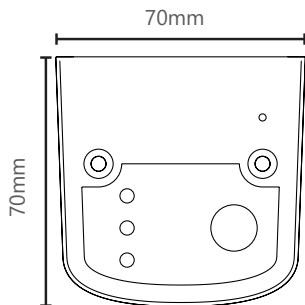

Die ROBIN WOOD GmbH garantiert einen einwandfreien Betrieb des Geräts nur mit den mitgelieferten Kabeln.

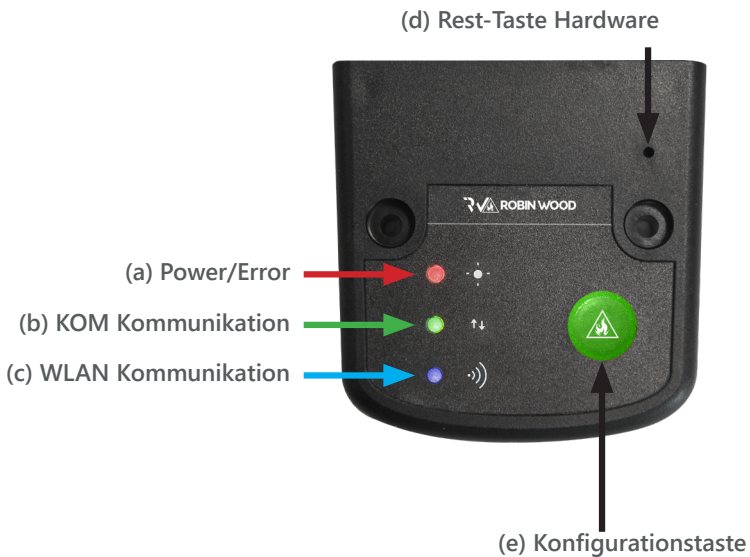



## INSTALLATION

1. **SMARTFIREModule an Stromversorgung anschließen:** LED (a) muss an sein und darf nicht blinken,
2. **Mit dem mitgeliefertem Kabel SMARTFIREModule mit der ROBIN WOOD Steuereinheit verbinden:** LED (b) muss an sein und darf nicht blinken. Blinkt LED (b), besteht möglicherweise ein Kommunikationsproblem bei der Steuereinheit. Vergewissern Sie sich, dass das Heizsystem an der Stromversorgung angeschlossen ist,
3. **WLAN-Kommunikation:** Ist die LED (c) an und blinkt nicht, signalisiert dies eine erfolgreiche Verbindung mit der SMART FIRE App und das Gerät kommuniziert korrekt.
4. **Reset-Taste Hardware (d):** bei andauernder Fehlfunktion des Geräts, Reset-Taste drücken.

Power	Blinken	Fehler
	Leuchten	OK
COM	Blinken	Fehlende Kommunikation der Steuereinheit
	Leuchten	Kommunikation erfolgreich
WLAN	Blinken	Mit WLAN nicht verbunden
	Leuchten	Mit WLAN verbunden
POWER/WLAN	Blinken	Konfigurationsphase



Wenn das Gerät während des normalen Betriebs offline ist, drücken Sie die Taste  3 Sekunden lang. Während der Konfiguration und während des laufenden Betriebs können sich die LED-Lampen von Leuchten auf Blinken umschalten.





## NEUE SMARTFIREModule KONFIGURATION

Verbinden Sie Ihr Smartphone zuerst mit dem WLAN zu Hause, bevor Sie mit der Konfiguration starten. Wählen Sie nun zu Beginn eine Sprache aus. Gehen Sie bei der Konfiguration des SMARTFIREModule folgendermaßen vor:

1. Erstellen Sie ein Account mit einer gültigen E-Mail-Adresse und einem Passwort Ihrer Wahl.
2. Wählen Sie zwischen „GERÄT HINZUFÜGEN“ und „GERÄT FINDEN“. Bei Inbetriebnahme des SMARTFIREModules wählen Sie „GERÄT HINZUFÜGEN“ aus

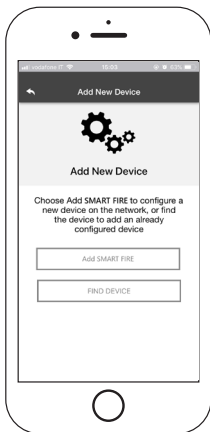



## NEUE SMARTFIREModule KONFIGURATION

3. Befolgen Sie die Anweisungen des Einrichtungsassistenten. Das SMARTFIREModule erstellt ein temporäres WLAN, mit dem Sie sich mit Ihrem Smartphone verbinden müssen. Auf diese Weise verbindet sich das Modul mit der App und dem zugehörigen Account.
4. Sobald die App und das SMARTFIREModule miteinander verbunden sind, müssen Sie das Heim-WLAN auswählen, mit dem sich das SMARTFIREModule verbinden soll.
5. Erstellen Sie einen Gerätenamen und geben Sie einen PIN Ihrer Wahl ein. Jedes SMARTFIREModule Gerät hat einen eigenen Namen und ein eigenes Passwort.

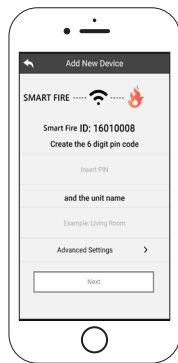

Wenn die Konfiguration fehlgeschlagen ist, können Sie den Konfigurationsvorgang des SMARTFIREModule wiederholen, indem Sie die Taste  8 Sekunden lang gedrückt halten.



Nachdem das SMARTFIREModule erfolgreich installiert ist, schließen Sie die App und öffnen Sie sie erneut.



Schließen Sie die App auch im Hintergrund, indem Sie das dort geöffnete App-Fenster schließen.

## Auf Apple-Geräten:

- Home-Taste zweimal drücken;
- Nach oben scrollen, um die Vorschau der SMARTFIRE-App zu schließen.

## Auf Android-Geräten:

- Untere Taste nach links drücken oder bei Android-Geräten mit virtuellen Tasten, untere Taste nach rechts drücken;
- Nach links scrollen, um die Vorschau der SMARTFIRE-App zu schließen.

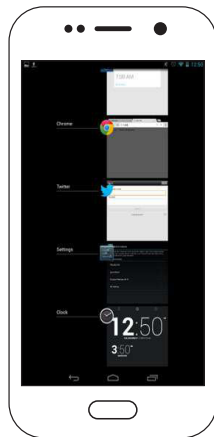
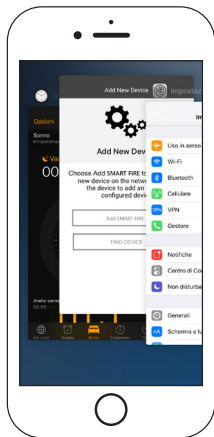





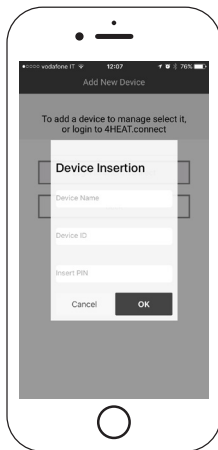

## VERBINDUNG AN EIN BEREITS KONFIGURIERTES SMARTFIREModule

Im Abschnitt „GERÄT FINDEN“, können Sie sich mit dem SMARTFIREModule verbinden, indem Sie den PIN eingeben. Dies funktioniert jedoch nur, wenn das SMARTFIREModule mit demselben WLAN wie das Smartphone verbunden ist. Auch eine Fernverbindung ist möglich (über die Datenverbindung Ihres Smartphones), indem Sie die Zugangsdaten des bereits konfigurierten SMARTFIREModules eingeben.



Auf der Homepage wird eine Liste der verbundenen Geräte mit der jeweiligen Haupttemperatur und des jeweiligen Betriebsstatus angezeigt.

Die zugehörigen SMARTFIRE-Geräte werden mit ihren Identifikationsnamen auf der Homepage mit den folgenden Statusinformationen angezeigt:

-  Betriebsstatus AUS
-  Betriebsstatus BLOCKIERUNG
-  Betriebsstatus AN
-  Gerät nicht verbunden oder nicht erreichbar
-  Update erforderlich

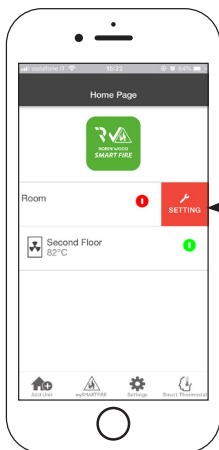

Zugriff auf die Einstellungen des zugehörigen SMARTFIRE-Modules (siehe „SMART FIRE EINSTELLUNGEN“ auf Seite 14 ).



Add Unit

In diesem Menü können Sie ein weiteres SMARTFIREModule-Gerät konfigurieren (siehe „NEUE SMARTFIREModule KONFIGURATION“ auf Seite 13 ).



mySMARTFIRE

Im **mySMARTFIRE-Menü** werden die Anmeldeinformationen der zugehörigen Geräte auf Ihrer App angezeigt. Mit der Taste  können Sie, über E-Mail- und Messaging-Dienste, Daten an andere Nutzer der SMARTFIRE-App senden und so eine gemeinsame Verwaltung des Heizsystems ermöglichen.



Settings

- **Account verwalten:** In diesem Menü können Sie ein neues Konto erstellen und die An-/Abmeldung vornehmen.
- **Zurücksetzen:** In diesem Menü können Sie die App auf Werkseinstellungen zurücksetzen.
- **Tutorial Wiedergabe:** In diesem Menü können Sie eine mehrmalige Wiedergabe des App-Tutorials vornehmen.  
**Mitteilungen verwalten:** In diesem Menü können Sie Mitteilungen über den Status des Heizsystems erlauben.
- **Sprache:** In diesem Menü können Sie Ihre bevorzugte Sprache auswählen.
- **Info:** In diesem Menü werden Ihnen die Informationen über die Version der installierten App angezeigt.
- **Download Anleitung:** In diesem Menü können Sie das Benutzerhandbuch der App herunterladen. Drücken Sie dazu auf das Speichersymbol, um das Handbuch im internen Speicher Ihres Smartphones zu sichern.

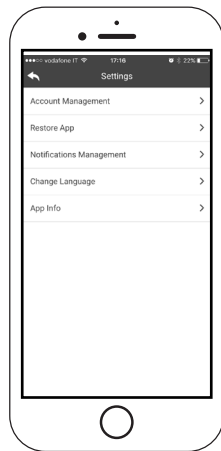



In diesem Menü können Sie sich mit den intelligenten Thermostaten verbinden, die in ihrem Heizsystem installiert sind. Um eine Verbindung zu den intelligenten Thermostaten herzustellen, geben Sie die Anmeldeinformationen des registrierten Accounts ein, die Sie bei der Konfiguration des Thermostats verwendet haben.

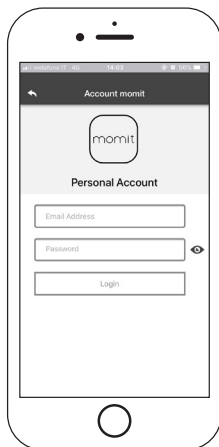
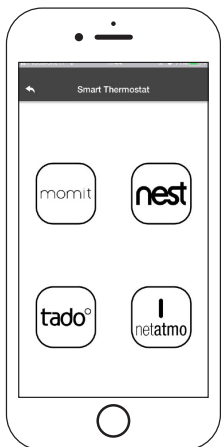



Zugriff auf das Einstellungsmenü des ausgewählten SMARTFIREModules:

- **Gerätename:** Sie können den Gerätenamen jederzeit ändern.
- **Gerätesymbol:** Sie können das Symbol, welches auf der Homepage zusehen ist, hierüber jederzeit ändern.
- **Fernassistenz:** Sie haben die Möglichkeit eine technischen Fernassistenz in Anspruch zu nehmen.
- **Widget:** Sie können Widgets auswählen, die auf der Hauptbildschirmseite der Gerätesteuerereinheit erscheinen.
- **Menü Einstellungen:** Sie können hierüber das Display der Menüfunktionen anpassen. Manche Funktionen sind eventuell nicht verfügbar, aufgrund der Konfiguration des Heizsystems (siehe „BILDSCHIRMSEITE INFORMATION“ auf Seite 23 ).
- **Info Einstellungen:** Sie können hierüber die Symbolgrößen des Info-Menüs auf dem Display personalisieren (siehe „BILDSCHIRMSEITE INFORMATION“ auf Seite 22 ).
- **Gerät Entfernen:** Sie können hierüber das aktuell ausgewählte Gerät entfernen.
- **Wetter Einstellungen:** Sie können hierüber das Widget, welches das lokale Wetter anzeigt, manuell ändern. Geben Sie dazu die Breiten- und Längengrade ein oder nutzen sie das GPS auf Ihrem Smartphone.
- **Info:** Hier werden Ihnen technische Informationen über den Produktcode der Steuereinheit und der Firmware-Version des Moduls angezeigt.
- **WLAN Info:** Hier werden Ihnen Informationen über das Netzwerk angezeigt, mit dem das SMARTFIREModule verbunden ist.

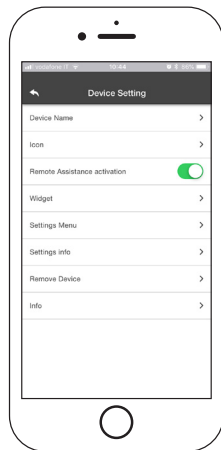







## Betriebsstatus:

Betriebsstatus und eventuelle Fehler werden angezeigt.



## Hauptthermostat:

Thermostatwerte des Heizsystems werden hier angezeigt. Halten Sie die Taste  gedrückt, um das Thermostat einzustellen.

Die Temperatur ändern Sie mittels der Tastenkombination  und  oder mittels dem Finger über die Farbleiste streichen.



## Widget:

Widgets zeigen Informationen über den Heizbetrieb an. Über das Menü  können Sie festlegen, welche Widgets Sie auf Ihrer Homepage sehen möchten .

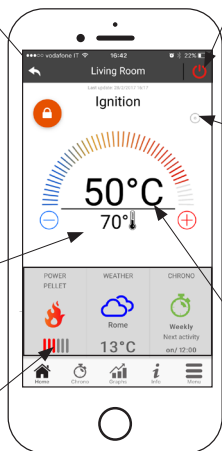

## System ON:

Drücken Sie auf dieses Symbol, um das SMARTFIREModule auszuschalten.

## System OFF:

Drücken Sie auf dieses Symbol, um das SMARTFIREModule anzuschalten.

## Synchronisation:

 Blinkt dieses Symbol, findet gerade ein Informationsaustausch zwischen der APP und dem SMARTFIREModule statt. Nach der Synchronisation werden die dadurch vorgenommenen Änderungen angezeigt.

## Main Temperature



Über das Chrono-Menü können Sie die Verwaltungsfunktion des Heizsystems in zwei unterschiedlichen Modi einstellen. Über dieses Symbol , können Sie die gewünschten Funktionsänderungen vornehmen.

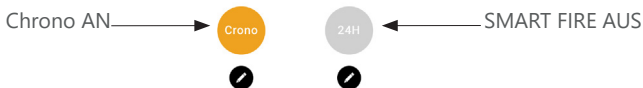

Im **Chrono** Modus können Sie 3 verschiedene Zeitfenster zum Ein- und Ausschalten des Heizsystems einstellen.

Sie können zwischen 3 Programmarten wählen:

- **Wöchentlich:** Einstellung von Montag bis Sonntag
- **Täglich:** Einstellung für jeden einzelnen Tag
- **Wochenende:** Einstellung für das Wochenende (Samstag und Sonntag) oder für unter der Woche (von Montag bis Freitag)

Drücken Sie nach jeder vorgenommenen Änderung in der Chrono-Funktion auf die Sichern-Taste, die sich am unteren Bildschirmrand befindet. Um ein Zeitfenster zurückzusetzen, streichen Sie auf dem entsprechenden Zeitfenster nach rechts und drücken Sie auf das Korb-Symbol.

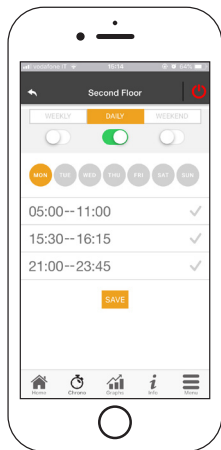



Mit der Funktion SMART FIRE können Sie, mit Hilfe des Assistenten, das Heizen in Ihrem Zuhause einfach und bequem verwalten, indem Sie Zeiten und Temperaturwerte an Ihrem täglichen Bedarf anpassen können. Während der assistentengestützten Verwaltung, werden Ihnen ein paar Fragen zu Ihrer täglichen Routine gestellt. Durch diese erstellt der SMART FIRE den wöchentlichen Zeitplan.

Sie können beim Thermostat zwischen drei Optionen wählen:



Mit dem **SMART FIRE** können Sie die Zeitfenster auch über den Hauptbildschirm



Heizprogramm auswählen und erstellen

Symbolleiste zum Verwalten

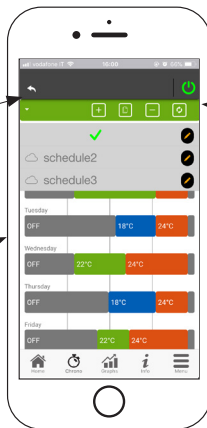
Über Assistenten erstellte Zeitfenster





1. **SMART FIRE Programm verwalten:** Im Dropdown-Menü, das sich am oberen Bildschirmrand befindet, sehen Sie die Programme, die Sie erstellt haben. Wählen Sie die Wolke aus, um das entsprechende Programm zu aktivieren. Gehen Sie auf das Symbol , um die Thermostate von jedem Zeitfenster zu ändern.
2. **Zeitfenster hinzufügen:** Über das Symbol  können Sie ein Zeitfenster spalten (siehe Abbildung): by the images:

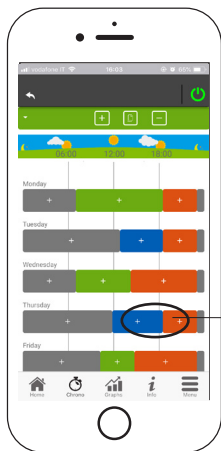

Über das „+“-Symbol können Sie ein Zeitfenster in zwei teilen. Dabei werden die Einstellungen des ersten Zeitfensters in zweiten übernommen.

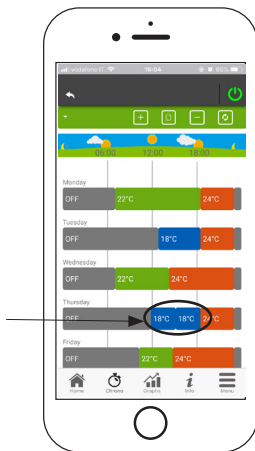



3. **Zeitfenster löschen:** Über die Taste  können Sie Zeitfenster löschen (siehe Abbildung).

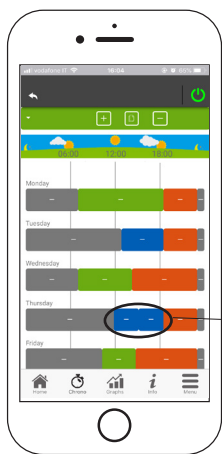

Um das gewünschte  
Zeitfenster zu löschen,  
drücken Sie auf das "-"  
Symbol.

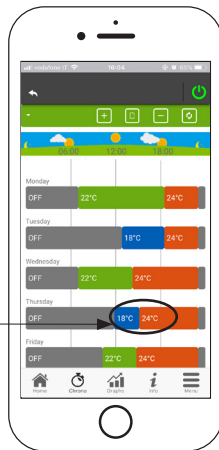

4. **Updates aktualisieren:** Über die Taste  synchronisieren Sie den SMART FIRE mit dem Gerät. Drücken Sie diese Taste immer, wenn eine Änderung vorgenommen wurde.



1. **Zeitfenster kopieren:** Über die Taste  können Sie die Zeitfenster von einem Tag auf einen anderen Tag kopieren. Drücken Sie danach auf die Bestätigungstaste, die Sie unten am Bildschirm finden.
2. **Zeitfenster ändern:** Wählen Sie ein Zeitfenster aus, um dieses zu verwalten (siehe Abbildung).

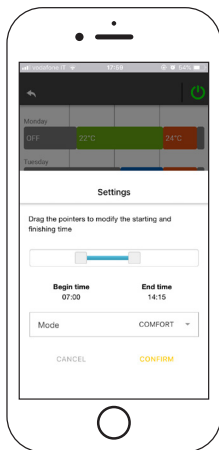
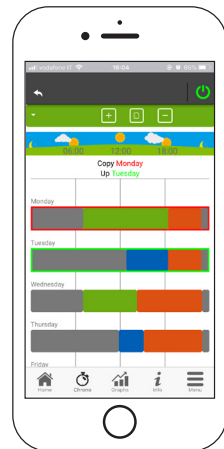



Auf dieser Seite sehen Sie die Grafiken, in denen die Werte vom SMARTFIREModule aufgezeichnet werden. Zwei verschiedene Grafiken sind verfügbar:

1. **Täglich:** Die angezeigten Werte werden über den Tagesverlauf des Heizsystems angezeigt. Sie können in der Grafik ein Zeitfenster von 0:00/12:00 oder von 12:00/0:00 anzeigen lassen. Außerdem können Sie den Status des Heizsystems (Aus, Normal, Blockierung etc.) anzeigen lassen. Die aufgezeichneten Werte werden für eine Woche lang gespeichert.
2. **Periodisch:** Hier sehen Sie die grafische Darstellung der Betriebsstunden pro Woche. Die aufgezeichneten Werte werden für ein Jahr lang gespeichert.

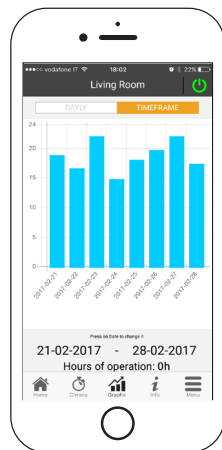
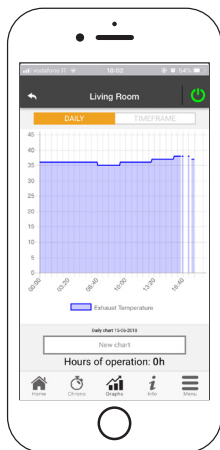

Auf dieser Seite werden Ihnen alle aufgezeichneten Werte der Steuereinheit angezeigt. Die anzuzeigenden Werte können Sie über das Einstellungsmenü des SMARTFIREModules einstellen (siehe SMART FIRE EINSTELLEN“ auf Seite 14 ).

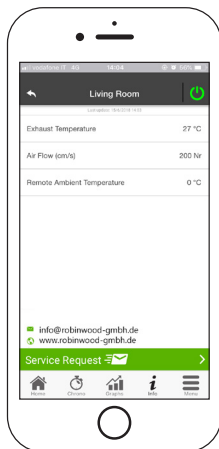

Sie können außerdem die Referenzdaten des Dienstleistungsanbieters einsehen und eventuelle Serviceanfragen per E-Mail senden. Falls die App für Sie speziell angepasst wurde, können Sie auch die Identifikationsdaten eingeben.





Über die Menüseite haben Sie Zugriff auf:

- **Leistung verwalten:** In diesem Menü können Sie Änderungen an der Verbrennungsleistung und/oder der Heizleistung vornehmen.
- **Thermostat verwalten:** In diesem Menü können Sie Änderungen am Hauptthermostat und an ggf. anderen Thermostaten vornehmen, wenn dies erforderlich ist.

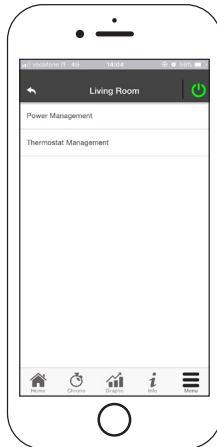

**ENGLISH**



SYSTEM STRUCTURE	2
LOCAL CONNECTION AND REMOTE CONNECTION	3
MECHANICAL SPECIFICATIONS	4
BUTTONS AND LED	5
INSTALLATION	6
NEW SMARTFIREModule CONFIGURATION	7
CONNECTION TO A SMARTFIREModule ALREADY CONFIGURED	10
HOME PAGE	11
SETTING SMART FIRE	14
SMART FIRE MANAGEMENT	15
CHRONO AND SMARTFIRE FUNCTION	16
GRAPH VIEW	21
INFORMATION PAGE	22
MENU PAGE	23

The structure is comprised of 3 macro-systems:

1. **SMARTFIREModule:** hardware device that interfaces the SMART FIRE control board with the local Wi-Fi router;
2. **SERVER CLOUD:** web server infrastructure that enables data storage and acts as a star point for remote communication;
3. **SMART FIRE:** mobile application available from Google Play Store and App Store for free, which allows the user to interface with the heating system.

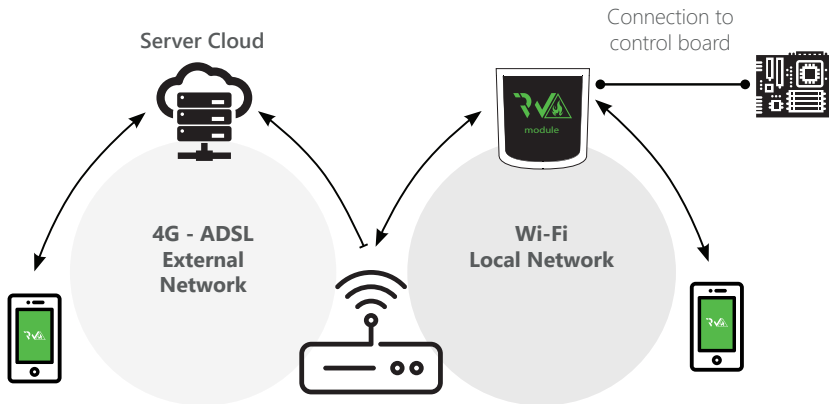



# LOCAL CONNECTION AND REMOTE CONNECTION

## Local connection

The connection between the SMARTFIREModule and the App is via the home Wi-Fi network, only if both are connected to the same Wi-Fi network.



## Remote connection

There is talk of remote connection when at the time of use of the App, the user is away from home. In this case the App takes advantage of the data coverage of your Smartphone and the Cloud Server allows the triangulation of the signal in order to manage the Module from a distance. Remote connection times may vary based on data network traffic, network connection conditions, and traffic to the server. In the worst case, connection times may be 5 minutes late.

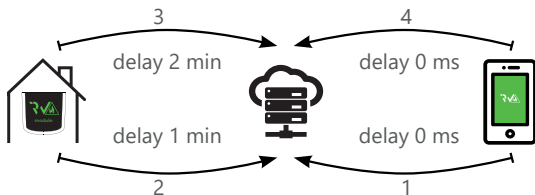

The remote connection can only be used if the user has previously registered in the Cloud Server, see the paragraph: "NEW SMARTFIREModule CONFIGURATION" at page 7



## MECHANICAL SPECIFICATIONS

Communication ports	RS232 RS485
Power supply	5V
Housing	Housing in ABS
Temperature range	-20° ÷ 60°
Fixing	self-tapping screws 3,5 mm

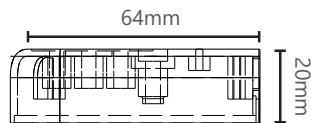
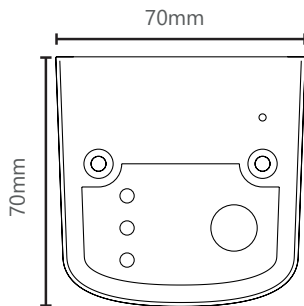

SMART FIRE guarantees the proper functioning of the device of the supplied cables.



## BUTTONS AND LED

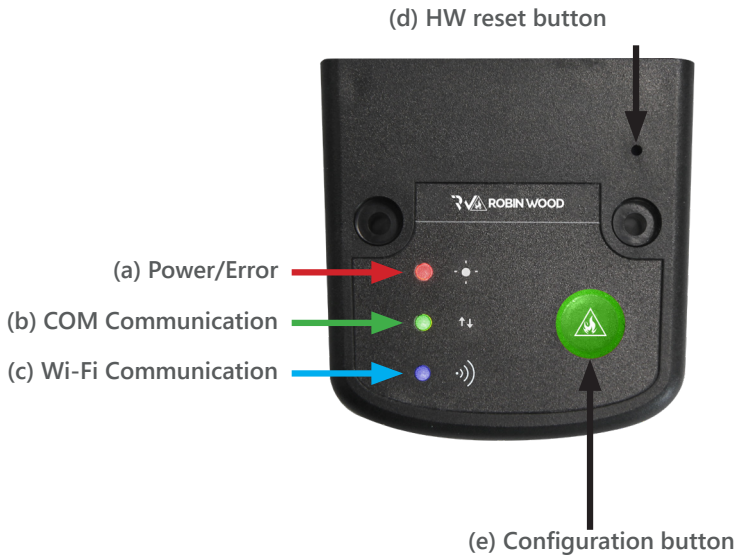



## INSTALLATION

1. **Connect the SMARTFIREModule to the power supply:** the LED (a) must be on and not flashing;
2. **Connect the SMARTFIREModule to the ROBIN WOOD board using the cable supplied in the kit:** the LED (b) must be on and not flashing, in case of flashing there may be problems communicating with the control board, make sure that the heating system is connected to the mains power supply;
3. **Wi-Fi communication:** with LED (c) solid the connection with the APP SMART FIRE has been successful and the device is communicating correctly;
4. **Hardware reset button (d):** press in case of persistent product malfunction.

Power	flashing	error
	solid	OK
COM	flashing	not communicating with the control board
	solid	Communication present
Wi-Fi	flashing	Wi-Fi is not configured
	solid	Wi-Fi connected
POWER/Wi-Fi	flashing	Configuration phase



If the device is offline during normal operation, press the  button for 3 seconds. During configuration and operation, the LED can change from solid to flashing light.





## NEW SMARTFIREModule CONFIGURATION

It is recommend to connect your Smartphone to the home Wi-Fi before starting the procedure. At the start, a language must be selected.

The configuration procedure is explained below:

1. Create an account with a valid email address and a password of your choice;
2. Choose between "ADD DEVICE" and "FIND DEVICE". If the SMARTFIREModule is switched on for the first time, "ADD DE VICE" must be selected.

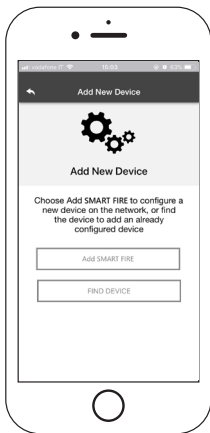



## NEW SMARTFIREModule CONFIGURATION

3. Follow the procedure. The SMARTFIREModule creates a temporary Wi-Fi to which you must connect with the Smartphone. In this way the Module will be connected to the app and the associated account;
4. Once the app and the SMARTFIREModule are connected, it is required to choose the home Wi-Fi to which the SMARTFIREModule device must connect;
5. Write a name for the device and enter a PIN of your choice. Each SMARTFIREModule device has its own name and password.

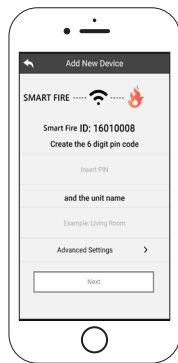

If the configuration procedure was not successful, the SMARTFIREModule can be reconfigured by pressing the  button for 8 seconds



## NEW SMARTFIREModule CONFIGURATION

After completing the installation procedure of the SMARTFIREModule, it is advisable to close the app and restart it.



Close the app between open windows in the background.

### **On Apple device:**

- Touch the Home button twice;
- Scroll up the preview of the SMART FIRE app to close it.

### **On android device:**

- Press the lower right button for virtual buttons or the lower left button for devices with real buttons;
- Scroll to the left to close the SMART FIRE app preview.

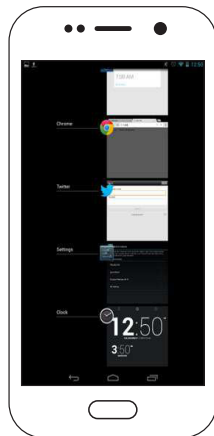
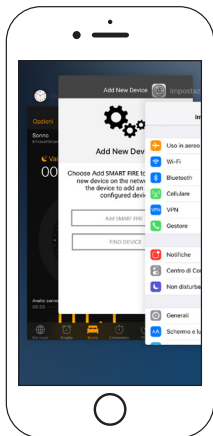





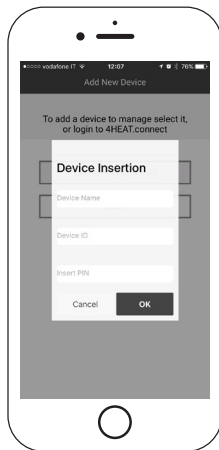

## CONNECTION TO A SMARTFIREModule ALREADY CONFIGURED

In the "FIND DEVICE" section, it is possible to connect to the SMARTFIREModule by entering the PIN code, only if the SMARTFIREModule is connected to the same Wi-Fi as the smartphone. It is also possible to connect remotely (using the data connection of your smartphone) by entering the access credentials of the already configured SMARTFIREModule device.



The Home Page displays the SMARTFIREModule including the temperature and functioning state.

The associated SMARTFIRE devices appear on the Home Page with their identification name. In the following manner:

-  Operating status OFF
-  Operating status BLOCK
-  Operating status ON
-  Device not connected or unreachable
-  Updating required

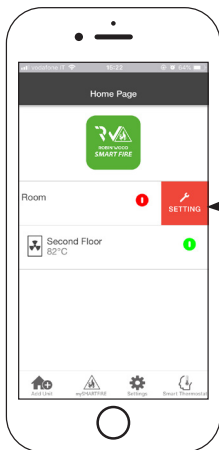

Access to the settings of the associated SMART FIRE Module device.  
"SETTING SMART FIRE" at page 14



Add Unit

This menu is used you to configure another SMARTFIREModule device.  
See page 13.



In **mySMARTFIRE** is shown the device credentials associated with your app.  
Using the button  it is possible to send, via e-mail and messaging services, the data to the SMART FIRE applications of other users, in order to share the Heating System management.



Settings

- **Account Management:** menu that allows you to create a new account or log in / out;
- **Restore App:** allows you to reset the app to the default conditions;
- **Re-enable Tutorial:** allows you to re-enable the app tutorial tutorial;
- **Notifications Management:** allows you to enable notifications of the heating system status;
- **Change Language:** allows you to set the app language;
- **Info App:** allows you to view information about the version of the installed app on your smartphone;
- **Download Instruction:** allows you to download the user manual of the app. Press the save icon to store the manual in the internal memory of the smartphone.

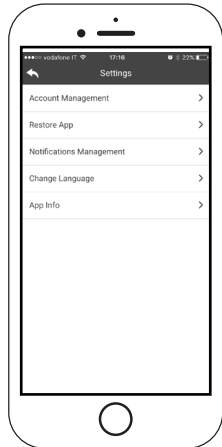



Smart Thermostat

It allows you to connect to the following smart thermostats installed in your home by entering the credentials of registered accounts during the configuration of the same.

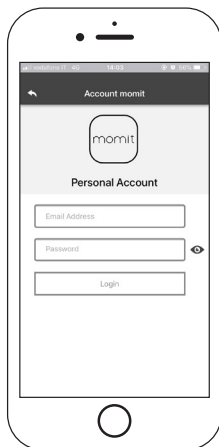
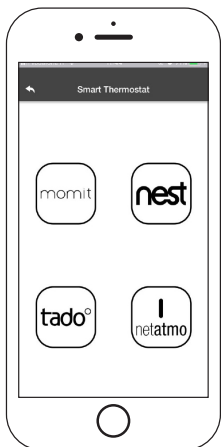



Access to the settings menu of the selected SMARTFIREModule.

- **Device Name:** use to change the name of the current device;
- **Icon:** change the unit display icon on the home page;
- **Remote Assistance Activation:** the user enables the possibility to receive remote technical assistance;
- **Widget:** allows you to select the Widgets that appear on the main device management screen;
- **Settings menu:** allows you to customize the display of menu functions. Some features may not be available due to the configuration of the heating system. "MENU PAGE" at page 23;
- **Settings Info:** allows you to customize the display of the system values of the info menu. "INFORMATION PAGE" at page 22;
- **Remove Device:** allows to delete the currently selected device;
- **Weather Modification:** the local weather, which appears as a widget, can be set manually by entering the desired latitude and longitude coordinates, or using the GPS of your Smartphone;
- **Info:** technical information concerning the product code of the control board and the firmware version of the Module;
- **Wi-Fi Info:** information about the internet network to which the SMARTFIREModule device is connected.

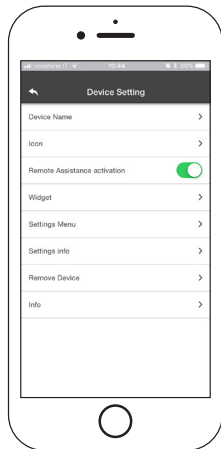







## Operation Status:

shows the state in which the system is functioning and any errors

## Main Thermostat:

displays the system thermostat. By keeping the key  pressed you enable the thermostat changes.

Use the  and  buttons or scroll through the color band to change the temperature.

## Widget:

displays information related to the system. You can decide which widget to show on the home page through the menu .



## System ON:

push to turn it off



## System OFF:

push to turn it on

## Synchronization:

 the flashing button indicates that the application and the module are exchanging information.

The synchronization result will be displayed in the end.

## Main Temperature

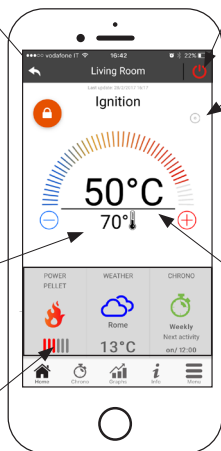



By accessing into the Chrono menu you can set the system management function in two different modes.

Pushing on  you can modify the selected modality.

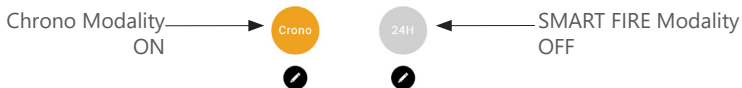

Entering the **CHRONO** modality you can set 3 different time slots for switching the SMART FIRE system on and off.

You can choose three types of programming:

- **Weekly:** Setting from Monday to Sunday;
- **Daily:** Setting up every single day;
- **Weekend:** Setting during the weekend (Saturday and Sunday) or during the weekdays (from Monday to Friday).

Each time this function is updated, press the Save button that appears at the bottom of the screen.

To reset the time slot use the basket that appears with the slide-touch to the right of the time slot.

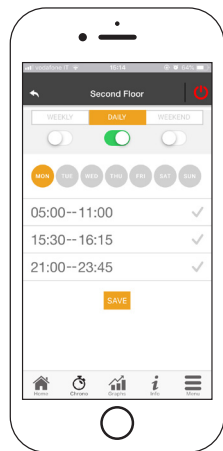



With the **SMART FIRE** function you can manage, by an assistant guided procedure, the domestic heating by setting the times and temperatures according to daily needs.

The assistant asks a few simple questions of the daily routine through which the SMART FIRE sets the weekly schedule.



It is possible to choose the thermostat for the three available options:

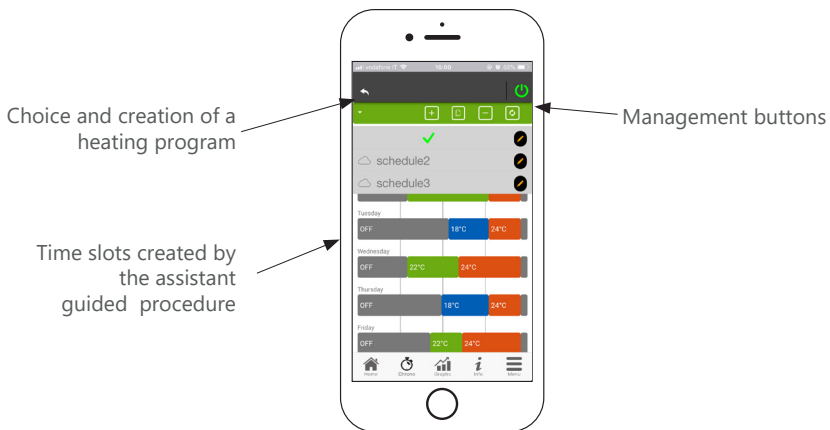

**SMART FIRE** allows you to manage time slots also from the main screen:





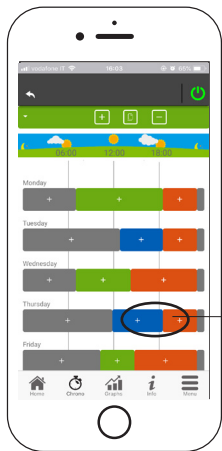

1. **SMART FIRE program management:** The drop-down menu at the top of the page shows the programs set by the user. Select the speech bubble to enable the program. Press on the symbol  to change the thermostats of each time slot.
2. **Add time slot:** By selecting the button  you can split a time slot, as shown by the images:

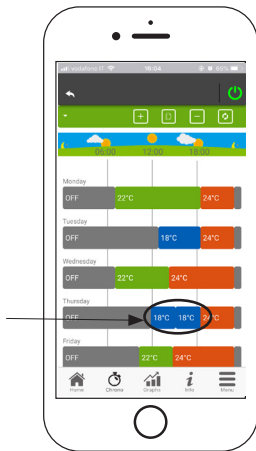

By pressing the "+" symbol, it is possible to divide a slot in two, keeping the same settings of the starting slot.





3. **Elimination of time slot:** by selecting the button  you can delete a time slot, as shown in the pictures:

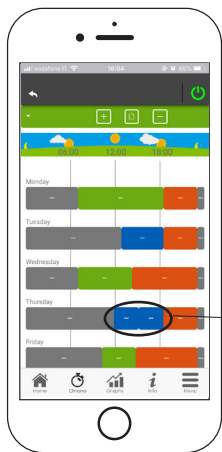

By pressing the "-" symbol, it is possible to delete the desired time slot.

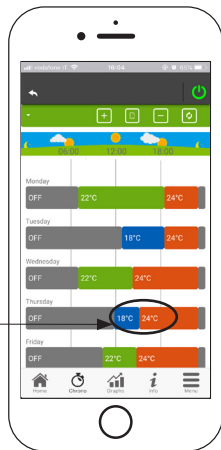

4. **Update changes:** Through the button the  SMART FIRE is synchronized with the device. Be sure to press it each time a change is made



5. **Copy of a time slot:** by selecting the button  you can copy the time slots from one day to the another. When finished, press the confirm button at the bottom of the page
6. **Change of time slot:** pressing on a time slot you access to the management menu, as indicated by the image:

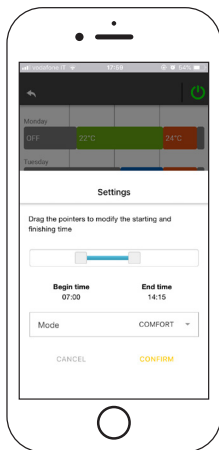
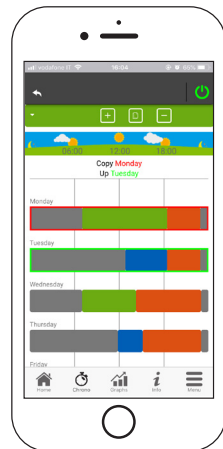

This section shows the graphs of the values logged on the server by the SMARTFIREModule. Two types of views are available:

1. **Daily:** the displayed values are represented during the daily of operation of the heating system. You can view the graphs of two time slots: 00: 00/12: 00 or 12: 00/00: 00. You can also choose to display the operating status of the heating system (ex. Off / Normal / Block etc.). The recorded data is saved for a week;
2. **Period:** it is a graphical representation of the system's operating hours based on a week. The recorded data are saved for a year.

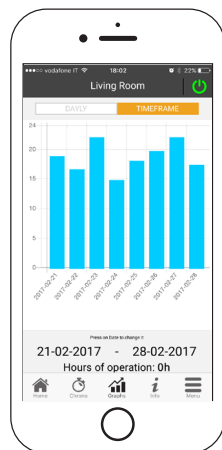
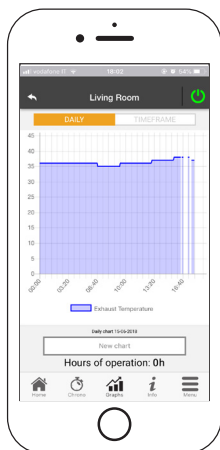

This page displays all the quantities registered by the control board.  
The quantities to be displayed can be set through the Setting Menu of the selected SMARTFIREModule. "SETTING SMART FIRE" at page 14

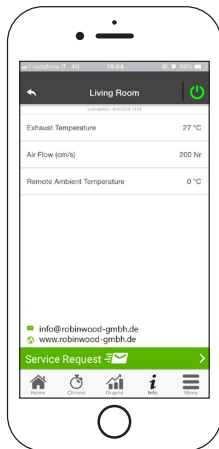

You can also view the service provider's reference data and send any support requests via email.  
If the App is customized for a specific customer, any identification data can be introduced.





On the Menu Page, you can access:

- **Power management:** in this menu it is possible to modify the combustion power and / or the heating power;
- **Thermostat management:** allows you to change the main thermostat and other thermostats if required by the heating system functions.



ITALIANO



ARCHITETTURA DEL SISTEMA	2
CONNESSIONE LOCALE E CONNESSIONE REMOTA	3
SPECIFICHE MECCANICHE	4
POSIZIONAMENTO TASTI E LED	5
INSTALLAZIONE	6
CONFIGURAZIONE NUOVO SMARTFIREModule	8
CONNESSIONE AD UN SMARTFIREModule GIÀ CONFIGURATO	10
HOME PAGE	12
SETTING SMART FIRE	14
GESTIONE SMART FIRE	15
FUNZIONALITÀ CRONO E SMART FIRE	16
VISUALIZZAZIONE GRAFICI	21
SCHERMATA INFO	22
SCHERMATA MENU	23

L'architettura prevede la presenza di 3 macro-sistemi:

1. **SMARTFIREModule:** dispositivo hardware che interfaccia la scheda di controllo Smart Fire e il router Wi-Fi locale;
2. **SERVER CLOUD:** infrastruttura web server che permette l'archiviazione dati e funge da centro stella nella comunicazione remota;
3. **SMART FIRE:** applicazione per smartphone disponibile da Google Play Store e da App Store in modo gratuito, che permette all'utente di interfacciarsi con il sistema di riscaldamento

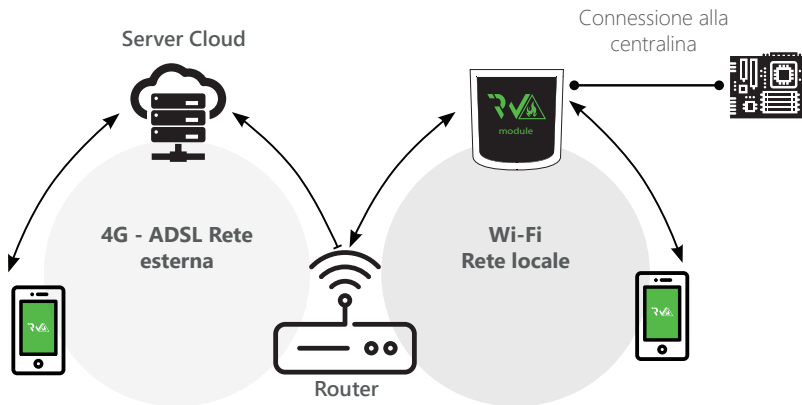



## Connessione Locale

La connessione tra il SMARTFIREModule e l'App avviene attraverso la rete Wi-Fi domestica, soltanto se entrambi sono connessi alla stessa rete Wi-Fi.



## Connessione Remota

Si parla di connessione remota quando al momento dell'utilizzo della App, l'utente si trova lontano da casa. In questo caso l'App usufruisce della copertura dati del proprio Smartphone e il Server Cloud permette la triangolazione del segnale per poter gestire il Module da lontano. I tempi di connessione remota possono variare in base al traffico rete dati, alle condizioni di connessione della rete e al traffico verso il server. Nel peggiore dei casi, i tempi di connessione possono raggiungere i 5 minuti di ritardo.

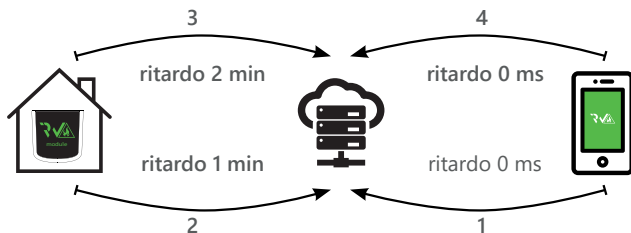

La modalità di connessione remota è utilizzabile solo se l'utente ha effettuato precedentemente la registrazione al Server Cloud, vedi paragrafo: "CONFIGURAZIONE NUOVO SMARTFIREModule" a pagina 10



Porte di comunicazione	RS232 RS485
Alimentazione	5V
Involucro	Housing in ABS
Range di temperatura	-20° ÷ 60°
Fissaggio	Viti autofilettanti da 3,5 mm

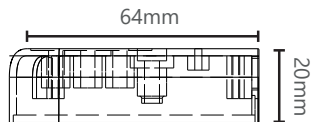
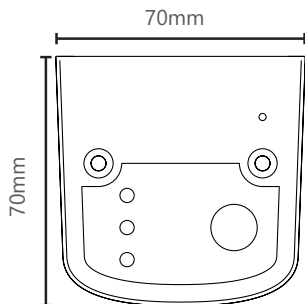

Robin Wood Smart Fire garantisce il funzionamento del dispositivo solo con i cavi forniti in dotazione.



## POSIZIONAMENTO TASTI E LED





1. **Collegare il SMARTFIREModule all'alimentatore:** il Led (a) deve essere acceso e non lampeggiante;
2. **Collegare il SMARTFIREModule alla scheda ROBIN WOOD tramite il cavo fornito nel kit:** il led (b) deve essere acceso e non lampeggiante, nel caso di lampeggiamento possono esserci dei problemi di comunicazione con la scheda di controllo, accertarsi che il sistema di riscaldamento sia collegato a rete elettrica;
3. **Comunicazione Wi-Fi:** con led (c) fisso la connessione con l'APP SMART FIRE ha avuto successo e il dispositivo sta comunicando correttamente;
4. **Tasto di reset hardware (d):** premere in caso di malfunzionamento persistente del prodotto.

<b>Power</b>	lampeggiante	stato errore
	fisso	stato OK
<b>COM</b>	lampeggiante	comunicazione della scheda di controllo non avvenuta
	fisso	comunicazione avvenuta
<b>Wi-Fi</b>	lampeggiante	connessione Wi-Fi non configurata
	fisso	Wi-Fi connesso
<b>POWER/ Wi-Fi</b>	lampeggiante	fase di configurazione



Se il dispositivo risulta offline durante il normale funzionamento premere il tasto  per 3 secondi. Durante la configurazione e il funzionamento i Led possono passare da luce fissa a lampeggiante.





Si consiglia di collegare fin da subito il proprio Smartphone alla rete Wi-Fi domestica.

All'avvio dell' APP viene richiesta di selezionare la lingua.

Di seguito viene spiegata la procedura di configurazione del dispositivo SMARTFIREModule:

1. Creare un account con un indirizzo email valido e una password a scelta.
2. Scegliere tra "AGGIUNGI DISPOSITIVO" e "TROVA DISPOSITIVO". Nel caso di prima accensione del SMARTFIREModule si deve selezionare "AGGIUNGI DISPOSITIVO".

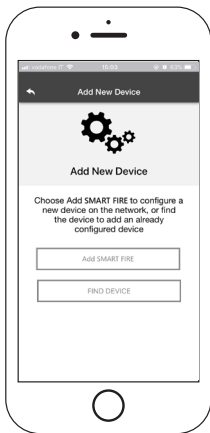



3. Seguire la procedura guidata. SMARTFIREModule crea una Wi-Fi provvisoria alla quale ci si deve collegare con lo Smartphone. In questo modo il Module sarà connesso all'app e all'account associato;
4. Una volta che l'app e il SMARTFIREModule sono connessi si richiede in questa fase di scegliere la Wi-Fi domestica a cui deve connettersi il dispositivo SMARTFIREModule;
5. Scrivere un nome per il dispositivo e inserire un PIN a scelta. Ogni dispositivo SMARTFIREModule ha un nome e una password propri.



Se la procedura di configurazione non è andata a buon fine, si può riconfigurare il SMARTFIREModule tenendo premuto per 8 secondi il tasto





Terminata la procedura di installazione del dispositivo SMARTFIREModule, si consiglia di chiudere la app e di riavviarla.



Chiudere la app tra le finestre aperte in background.

### **Su dispositivi Apple:**

- Tocca due volte il tasto Home;
- Scorri verso l'alto l'anteprima dell'app SMART FIRE per chiuderla.

### **Su dispositivi Android:**

- Premere il tasto in basso a destra per dispositivi con tasti virtuali o il tasto in basso a sinistra per dispositivi con tasti fisici;
- Scorri verso sinistra l'anteprima dell'app SMART FIRE per chiuderla.

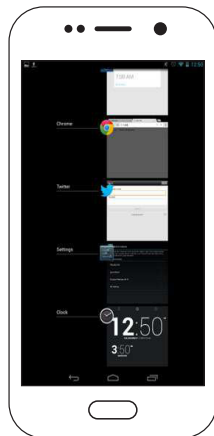
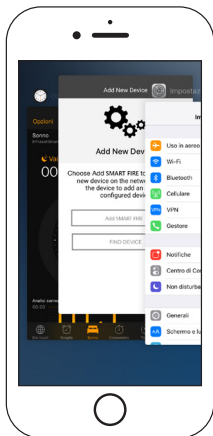





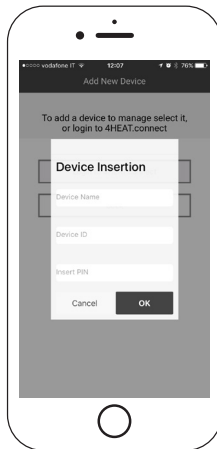

Nella sezione "TROVA DISPOSITIVO" è possibile connettersi al SMARTFIREModule inserendo il codice PIN, solo se il SMARTFIREModule è connesso alla stessa Wi-Fi dello smartphone. E' possibile inoltre connettersi da remoto (utilizzando la connessione dati del proprio smartphone) inserendo le credenziali di accesso del dispositivo SMARTFIREModule già configurato.





Nella Home Page viene visualizzato l'elenco dei dispositivi collegati e per ognuno viene mostrata la temperatura principale e lo stato.

I dispositivi SMART FIRE associati appaiono nella schermata Home con il loro nome identificativo. Viene segnalato:

-  Stato di funzionamento SPENTO
-  Stato di funzionamento BLOCCO
-  Stato di funzionamento ACCESO
-  Dispositivo non collegato o irraggiungibile
-  Aggiornamento necessario

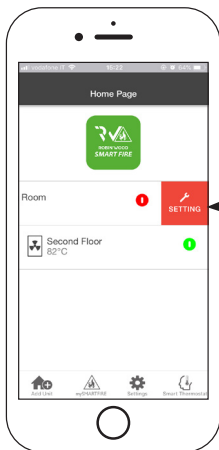

Accesso alle impostazioni del dispositivo SMARTFIREModule associato.  
"SETTING SMART FIRE" a pagina 16



Add Unit

Questo menu permette di configurare un altro dispositivo SMARTFIREModule. "CONFIGURAZIONE NUOVO SMARTFIREModule" a pagina <EN>



mySMARTFIRE

Nel menu mySMARTFIRE vengono elencate le credenziali dei dispositivi associati alla propria app.

Attraverso il tasto  è possibile inviare, tramite servizi di e-mail e messaggistica, i dati alle applicazioni SMART FIRE di altri utenti, permettendo la condivisione della gestione del Sistema di Riscaldamento.



Settings

- Gestione Account: menu che permette di creare un nuovo account o di effettuare il Login/Logout;
- Ripristina App: permette di resettare la APP alle condizioni di Default;
- Riabilita Tutorial: permette di riabilitare il tutorial di guida alla app;
- Gestione Notifiche: permette di abilitare le notifiche dello stato del sistema di riscaldamento;
- Lingua: permette di impostare la lingua;
- Info App: permette di visualizzare le informazioni relative alla versione della APP installata sul proprio smartphone;
- Download Manuale: permette di scaricare il manuale utente di spiegazione all'utilizzo della APP. Premere l'icona di salvataggio per memorizzare il manuale nella memoria interna dello smartphone;

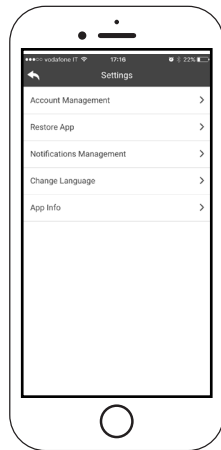



Permette di collegarsi alle applicazioni di gestione dei termostati intelligenti installati nel proprio sistema domestico. Per collegarsi al termostato intelligente inserire le credenziali di account registrate durante la configurazione dello stesso.

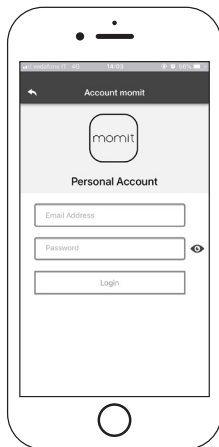
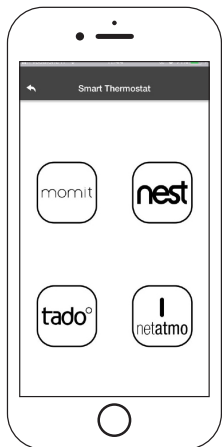



Accesso al menu di impostazioni riguardante il SMARTFIREModule selezionato:

- **Nome Dispositivo:** è possibile cambiare il nome del dispositivo corrente;
- **Icona Dispositivo:** modifica l'icona di visualizzazione dell'unità nella home page;
- **Abilitazione Assistenza Remota:** l'utente abilita la possibilità di ricevere assistenza tecnica in remoto;
- **Widget:** permette di selezionare i Widget che appaiono nella schermata principale di gestione del dispositivo;
- **Impostazioni Menu:** permette di personalizzare la visualizzazione delle funzioni di menu. Alcune funzioni possono non essere disponibili a causa della configurazione del sistema di riscaldamento. Vedi "SCHERMATA MENU" a pagina 25;
- **Impostazioni Info:** permette di personalizzare la visualizzazione delle grandezze di sistema del menu info. Vedi "SCHERMATA INFO" a pagina 24;
- **Elimina Dispositivo:** permette di eliminare il dispositivo attualmente selezionato;
- **Modifica Meteo:** il meteo locale, che appare come widget, può essere impostato manualmente inserendo le coordinate di latitudine e longitudine desiderate, oppure utilizzando il GPS del proprio Smartphone;
- **Info:** informazioni tecniche relative al codice prodotto della scheda di controllo e alla versione firmware del Module;
- **Info Wi-Fi:** informazioni relative alla rete internet alla quale il dispositivo SMARTFIREModule è connesso.

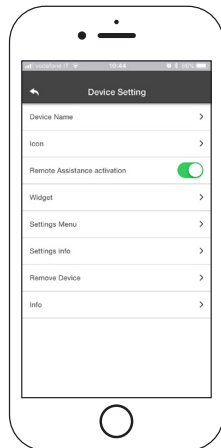







## Stato Funzionamento:

mostra lo stato in cui si trova il sistema ed eventuali errori.

## Termostato Principale:

visualizza il termostato del sistema.

Tenendo premuto il tasto  si abilita la modifica del termostato.

Con i tasti  e  oppure scorrendo con il dito sulla banda a colori si varia la temperatura.

## Sistema ACCESSO:

premere per spegnerlo

## Sistema SPENTO:

premere per accenderlo

## Sincronizzazione:

 lampeggiante indica che l'applicazione e il modulo si stanno scambiando informazioni. Al termine viene dato riscontro dell'esito della modifica.

## Temperatura Principale

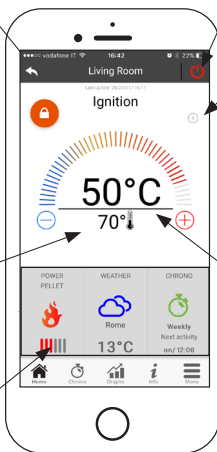

## Widget:

visualizzano le informazioni relative al funzionamento. Si può decidere quali widget mostrare nella schermata principale attraverso il menù .



Accedendo al menu Crono si può impostare la funzione di gestione del sistema, in due differenti modalità.

Premendo su  si accede alla modifica della funzione desiderata.



Entrando nella funzione **CRONO** si possono impostare 3 differenti fasce orarie per l'accensione e lo spegnimento del sistema di riscaldamento.

Si possono scegliere tre tipi di programmazione:

- **Settimanale:** Impostazione dal Lunedì alla Domenica;
- **Giornaliero:** Impostazione di ogni singolo giorno;
- **Weekend:** Impostazione durante il weekend (sabato e domenica) oppure durante i giorni feriali (dal lunedì al venerdì).

Ogni volta che questa funzione viene aggiornata è necessario premere il tasto di Salvataggio che compare a fondo schermata. Per resettare la fascia oraria utilizzare il cestino che appare con lo slide-touch a destra della fascia oraria.

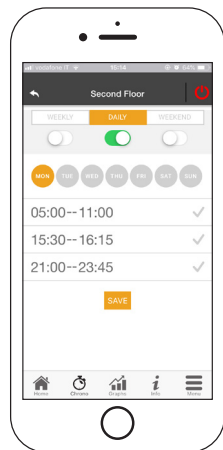



La funzione **SMART FIRE** permette, attraverso una procedura guidata, di poter gestire il riscaldamento domestico, andando ad impostare orari e temperature, in base alle esigenze quotidiane.

Durante la procedura guidata vengono poste poche semplici domande di routine quotidiana, attraverso le quali lo SMART FIRE imposta la programmazione settimanale.



Viene data la possibilità di scegliere il termostato per le tre fasce disponibili:



**SMART FIRE** permette di gestire le fasce orarie anche dalla schermata principale:





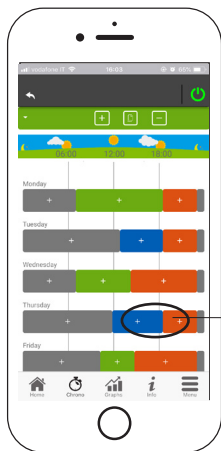

1. **Gestione programmi SMART FIRE:** il menu a tendina in alto a sinistra mostra i programmi impostati dall'utente. Selezionare la nuvoletta per abilitare il programma. Premere sul simbolo  per modificare i termostati di ogni fascia.
2. **Aggiungi fascia oraria:** selezionando il pulsante  si può sdoppiare una fascia oraria, come viene mostrato dalle immagini:

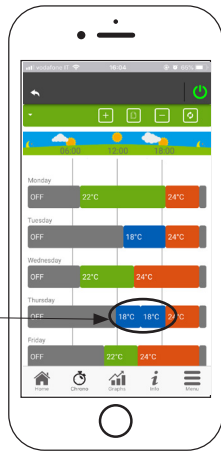

Premendo sul simbolo "+", si divide la fascia in due, mantenendo le stesse impostazioni della fascia di partenza





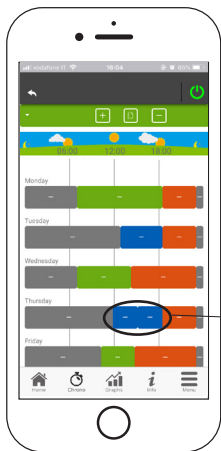

3. **Eliminazione fascia oraria:** selezionando il pulsante  si può eliminare una fascia oraria, come mostrato dalle immagini:

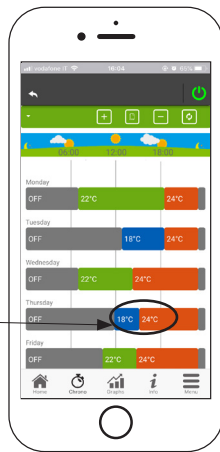

Premendo sul simbolo "-" , si elimina la fascia oraria desiderata



4. **Aggiornamento modifiche:** attraverso il pulsante  si sincronizza lo Smart Fire con il dispositivo. Accertarsi di premerlo ogni volta che viene effettuata una modifica.



- Copia di una fascia oraria:** Selezionando il pulsante  posso copiare le fasce orarie da un giorno all'altro. Al termine premere il tasto di conferma in fondo alla pagina.
- Modifica della fascia oraria:** Premendo su una fascia oraria si accede al menu di gestione, come indicato dall'immagine:

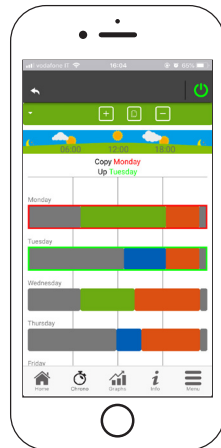
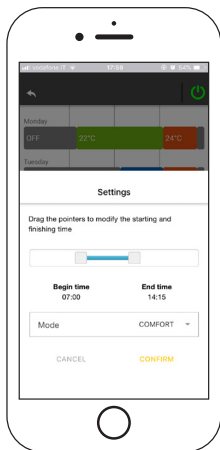

In questa sezione vengono visualizzati i grafici delle grandezze loggate sul server dal SMARTFIREModule. Sono disponibili due tipi di visualizzazioni:

1. **Giornaliera:** le grandezze visualizzate sono rappresentate nell'arco della giornata di funzionamento del sistema di riscaldamento. Si possono visualizzare i grafici di due fasce orarie: 00:00/12:00 o 12:00/00:00. Si può scegliere inoltre di visualizzare anche gli stati di funzionamento del sistema di riscaldamento (es. Spento/Normale/Blocco etc.). I dati registrati restano in memoria con cadenza settimanale;
2. **Periodo:** rappresentazione grafica su base settimanale delle ore di funzionamento del sistema. I dati registrati restano in memoria con cadenza annuale.

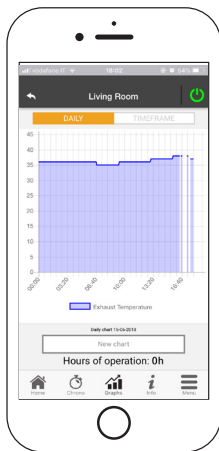

In questa schermata vengono visualizzate tutte le grandezze registrate dalla scheda di controllo. Le grandezze da visualizzare possono essere impostate attraverso il Setting Menu del dispositivo SMARTFIREModule selezionato. "SETTING SMART FIRE" a pagina 16.

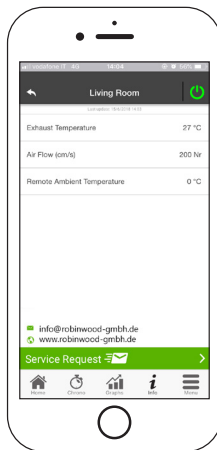

È inoltre possibile visualizzare i dati di riferimento del fornitore del servizio e inviare eventuali richieste di assistenza tramite mail. Qualora la App sia personalizzata per uno specifico cliente, è possibile introdurre gli eventuali dati d'identificazione.





Nella schermata Menu è possibile accedere a:

- **Gestione Potenza:** in questo menu è possibile modificare la potenza di combustione e/o l'eventuale potenza di riscaldamento;
- **Gestione Termostato:** permette di modificare il termostato principale ed altri eventuali termostati qualora previsto dalle funzionalità del Sistema di Riscaldamento.

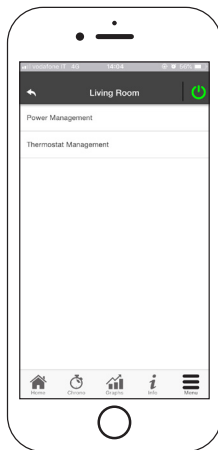

ESPAÑOL



ARQUITECTURA DEL SISTEMA	2
CONEXIÓN LOCAL Y CONEXION REMOTA	3
CARACTERÍSTICAS MECÁNICAS	4
POSICIONAMIENTO TECLAS Y LEDS	5
INSTALACIÓN	6
NUEVA CONFIGURACIÓN DE SMARTFIREModule	7
CONEXIÓN A UN DISPOSITIVO SMARTFIREModule YA CONFIGURADO	10
HOME PAGE	11
SETTING SMART FIRE	14
GESTIÓN SMART FIRE	15
FUNCIÓN CHRONO Y SMART FIRE	16
VISUALIZACIÓN DE GRÁFICOS	21
PANTALLA DE INFORMACIÓN	22
PANTALLA DE MENU	23

La arquitectura incluye 3 macro-sistemas

1. **SMARTFIREModule:** dispositivo hardware que pone en comunicación la placa de control SMART FIRE con el router wifi local;
2. **SERVER CLOUD:** server web que permite el almacenamiento datos y hace de centro estrella en la comunicación remota;
3. **SMART FIRE:** aplicación de smartphone disponible en Google Play Store y App Store gratis, que permite al usuario interactuar con el sistema de calefacción.

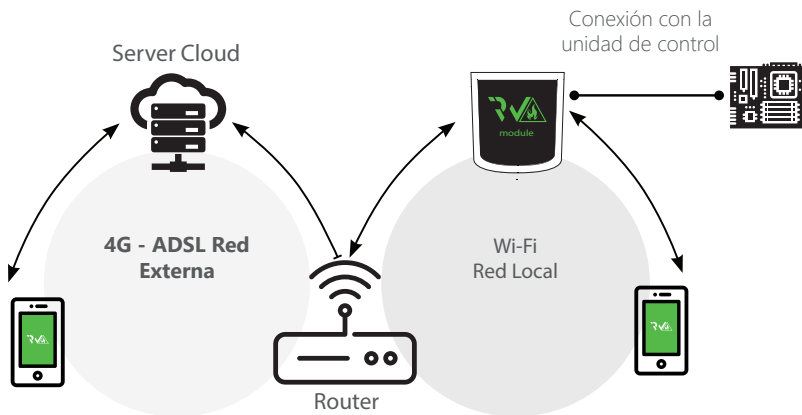



## Conexión Local

La conexión entre el SMARTFIREModule y la APLICACIÓN se realiza a través de la red Wi-Fi doméstica, solo si ambas están conectadas a la misma red Wi-Fi.



## Conexión Remota

Se habla de conexión remota cuando, en el momento del uso de la aplicación, el usuario está fuera de casa. En este caso, la aplicación aprovecha la cobertura de datos de su Smartphone y el Cloud Service permite la triangulación de la señal para gestionar el módulo a distancia. Los tiempos de conexión remota pueden variar según el tráfico de red de datos, las condiciones de conexión de red y el tráfico al servidor. En el peor de los casos, los tiempos de conexión pueden llegar a tardar 5 minutos.

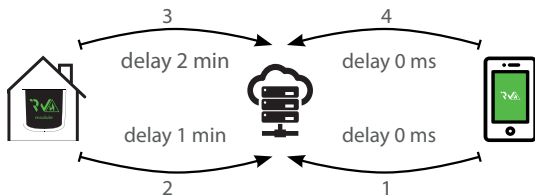

La conexión remota solo se puede utilizar si el usuario se ha registrado previamente en el Cloud Service; consulte el párrafo: "NUEVA CONFIGURACIÓN DE SMARTFIREModule" en la página 7.



Puertos de comunicación	RS232 RS485
Alimentación	5V
Alojamiento	Housing in ABS
Rango de temperatura	-20° ÷ 60°
Anclaje	Tornillos taladradores de 3.5 mm

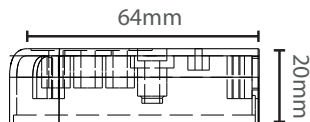
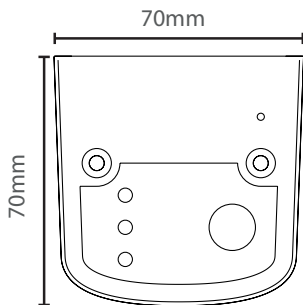

SMART FIRE garantiza el funcionamiento del dispositivo sólo con los cables en dotación.



## POSICIONAMIENTO TECLAS Y LEDS





## INSTALACIÓN

1. **Conecte el SMARTFIREModule a la fuente de alimentación:** el LED (a) debe estar encendido y no parpadeando;
2. **Conecte el SMARTFIREModule a la placa ROBIN WOOD usando el cable suministrado en el kit:** el LED (b) debe estar encendido y no parpadeando; en caso de parpadeo, pueden haber problemas de comunicación con la placa de control, asegúrese de que el sistema de calefacción esté conectado a la red eléctrica;
3. **Comunicación Wi-Fi:** con LED (c) fijo la conexión con la APLICACIÓN SMART FIRE ha sido exitosa y el dispositivo se está comunicando correctamente;
4. **Botón de restablecimiento de hardware (d):** presione en caso de mal funcionamiento persistente del producto.

<b>Power</b>	parpadeo	error
	luz	OK
<b>COM</b>	parpadeo	Comunicación de la placa no realizada
	luz	Comunicación realizada
<b>Wi-Fi</b>	parpadeo	Conexión Wi-Fi no configurada
	luz	Wi-Fi conectado
<b>POWER/ Wi-Fi</b>	parpadeo	Fase de configuración



Si el dispositivo está fuera de línea durante el funcionamiento normal, presione el botón  durante 3 segundos. Durante la configuración y el funcionamiento, los LED pueden cambiar de luz fija a luz intermitente.





## NUEVA CONFIGURACIÓN DE SMARTFIREModule

Recomendamos conectar desde el principio su Smartphone a la red Wi-Fi del hogar.

Quando se inicie de la aplicación, se solicita seleccionar el idioma.

El procedimiento para configurar el SMARTFIREModule se explica a continuación:

1. Cree una cuenta con una dirección de correo electrónico válida y una contraseña de su elección.
2. Elija entre "AGREGAR DISPOSITIVO" y "ENCONTRAR DISPOSITIVO". Si el SMARTFIREModule se enciende por primera vez, se debe seleccionar "AGREGAR DISPOSITIVO".

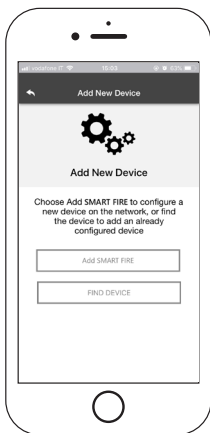



## NUEVA CONFIGURACIÓN DE SMARTFIREModule

3. Siga el procedimiento guiado. El SMARTFIREModule crea un Wi-Fi temporal al que debe conectarse con el teléfono inteligente. De esta forma, el Módulo se conectará a la aplicación y a la cuenta asociada;
4. Una vez que la aplicación y el SMARTFIREModule están conectados, en esta etapa se requiere elegir el Wi-Fi doméstico al que debe conectarse el dispositivo SMARTFIREModule;
5. Escriba un nombre para el dispositivo e ingrese un PIN de su elección. Cada dispositivo SMARTFIREModule tiene su propio nombre y contraseña

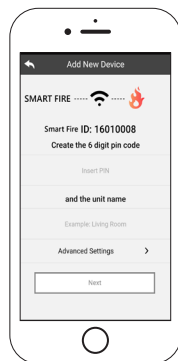

Si el procedimiento de configuración no fue exitoso, el SMARTFIREModule puede reconfigurarse presionando el botón  durante 8 segundos



## NUEVA CONFIGURACIÓN DE SMARTFIREModule

Después de completar el procedimiento de instalación del dispositivo SMARTFIREModule, es recomendable cerrar la aplicación y reiniciarla.



Cierre la aplicación entre las ventanas abiertas en el fondo.

### En dispositivos Apple:

- Toque dos veces la tecla Home;
- Desplace hacia arriba la anticipación del la APP SMART FIRE para cerrarla.

### En dispositivos Android:

- Pulse la tecla en la parte inferior derecha para los dispositivos con teclas virtuales o la tecla en la parte inferior izquierda para dispositivos con teclas físicas;
- Desplace hacia la izquierda la anticipación del la APP SMART FIRE para cerrarla.

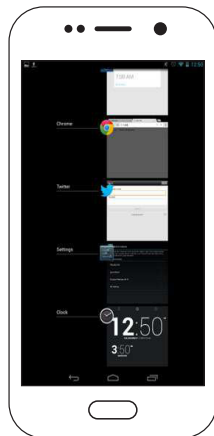
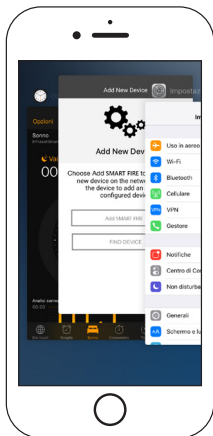



## CONEXIÓN A UN DISPOSITIVO SMARTFIREModule YA CONFIGURADO

En la sección "ENCONTRAR DISPOSITIVO", es posible conectarse al SMARTFIREModule introduciendo el código PIN, sólo si el SMARTFIREModule está conectado al mismo Wi-Fi que el Smartphone.

También es posible conectarse de forma remota (utilizando la conexión de datos de su Smartphone) ingresando las credenciales de acceso del dispositivo SMARTFIREModule ya configurado.

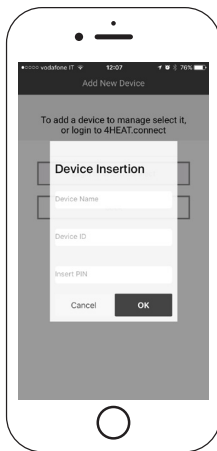



En la página de Inicio se muestra la lista de dispositivos conectados y la temperatura y el estado principal para cada uno.

Los dispositivos SMART FIRE asociados aparecen en la página de inicio con su nombre de identificación.

Se informa:

- ❶ Estado de funcionamiento OFF
- ❷ Estado de funcionamiento BLOQUEO
- ❸ Estado de funcionamiento ENCENDIDO
- ❹ Dispositivo no conectado o inalcanzable
- 🔄 Actualización requerida

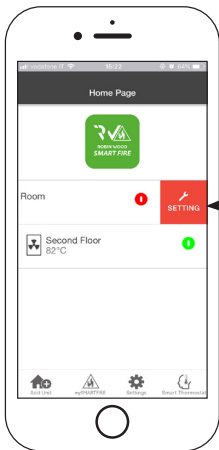

Acceso a la configuración del dispositivo del SMARTFIREModule asociado.  
"SETTING SMART FIRE" en la página 14



Add Unit

Este menú le permite configurar otro dispositivo SMARTFIREModule.  
Ver el procedimiento descrito a pag. 13.



mySMARTFIRE

En el menú mySMARTFIRE se enumeran las credenciales de los dispositivos asociados a su aplicación

Con la tecla  es posible enviar, a través de e-mail y servicios de mensajería, los datos a las aplicaciones SMART FIRE de otros usuarios, lo que permite compartir la gestión del sistema de calefacción.



Settings

- **Gestión Cuenta:** menú que le permite crear una nueva cuenta o iniciar sesión / salir;
- **Restaurar App:** le permite restablecer la aplicación a las condiciones predeterminadas;
- **Vuelva a habilitar el tutorial:** le permite volver a habilitar el tutorial de la aplicación;
- **Gestión Notificaciones:** permite activar las notificaciones sobre el estado del sistema de calefacción;
- **Cambio de Idioma:** le permite configurar el idioma;
- **Info App:** le permite ver información sobre la versión de la aplicación instalada en su Smartphone;
- **Descarga Instrucciones:** permite descargar el manual del usuario explicando el uso de la APLICACIÓN. Presione el icono guardar para almacenar el manual en la memoria interna del teléfono inteligente.

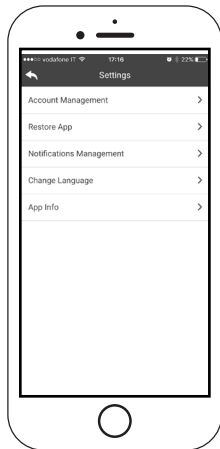



Smart Thermostat

Le permite conectarse a las aplicaciones de administración de termostatos inteligentes instalados en su sistema doméstico. Para conectarse al termostato inteligente ingrese la cuenta que se hayan registrado durante la configuración del mismo

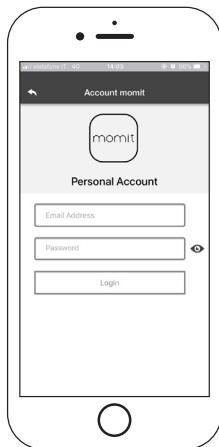
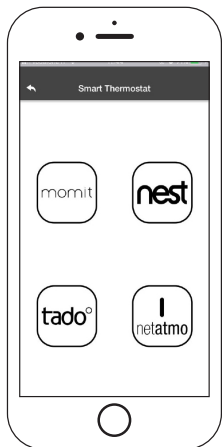



Acceda al menú de configuración para el Módulo SMART FIRE seleccionado.

- **Nombre Dispositivo:** es posible cambiar el nombre del dispositivo actual;
- **Icono:** modifica el icono de visualización de la unidad en la página de inicio;
- **Habilitación Asistencia Remota:** el usuario habilita la posibilidad de recibir asistencia técnica remota;
- **Widget:** le permite seleccionar los widgets que aparecen en la pantalla principal de gestión del dispositivo;
- **Ajustes Menú:** le permite personalizar la visualización de las funciones del menú. Algunas características pueden no estar disponibles debido a la configuración del sistema de calefacción. "PANTALLA DE MENU" en la página 23
- **Ajustes Info:** le permite personalizar la visualización de los valores del sistema del menú de información, "PANTALLA DE INFORMACIÓN" en la página 22
- **Elimina Dispositivo:** permite eliminar el dispositivo actualmente seleccionado;
- **Cambiar clima:** las condiciones meteorológicas que aparecen como widget, se pueden configurar manualmente introduciendo las coordenadas de latitud y longitud deseadas, o utilizando el GPS de su Smartphone;
- **Info:** información técnica sobre el código de producto del panel de control y la versión de firmware del Módulo;
- **Info Wi-Fi:** información sobre la red de Internet a la que está conectado el dispositivo SMARTFIREModule.

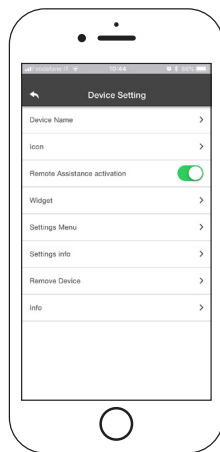







## Estado de funcionamiento:

muestra el estado en que se encuentra el sistema y cualquier error ocurrido.

## Termostato principal:

muestra el termostato del sistema.

Mantener presionado el tasto  se permite la modificación del termostato.

Use las teclas  o  para desplazarse por la banda de color para cambiar la temperatura.

## Widget:

demostrar información relacionada con la operación. Se puede decidir qué widgets mostrar en la página principal a través del menú .

## Sistema encendido:

presione para apagarlo

## Sistema Apagado:

presione para encenderlo

## Sincronización:

 La tecla parpadeante indica que la aplicación y el módulo están intercambiando informaciones. El resultado de la sincronización se mostrará al final del proceso.

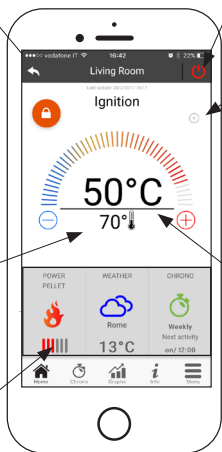

## Temperatura principal



Al acceder al menú Chrono, se puede ajustar la función de gestión del sistema en dos modalidades diferentes.

Presionando  se accede a la modificación de la función deseada.

Modo Chrono  
encendido



SMART FIRE modo  
está desactivado

Dentro de la función **CRONO** se pueden ajustar tres distintas franjas horarias para encender y apagar el sistema de calefacción.

Se puede elegir entre tres tipos de programación:

- Semanal: configuración de lunes a domingo;
- Diaria: ajuste de cada día;
- Fin de semana: ajuste durante el fin de semana (Sábado y domingo) o durante los días de la semana (de lunes a viernes).

Cada vez que se actualiza esta función es necesario pulsar el botón Guardar que aparece en la parte inferior de la pantalla.

Para restablecer franja horaria, utilice la papelera que aparece con con deslizador táctil a su derecha.

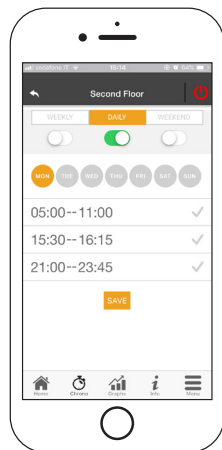



La función **SMART FIRE** permite, a través de un procedimiento guiado, gestionar la calefacción doméstica, estableciendo tiempos y temperaturas, de acuerdo con las necesidades diarias. Durante el procedimiento guiado se les hacen unas simples preguntas de rutina diaria, a través de las cuales el SMART FIRE ajusta la programación semana. Es posible elegir el termostato para las tres franjas disponibles:





**SMART FIRE** permite administrar las franjas horarias incluso desde la página principal:

Elección y creación de un programa de calefacción

Teclas de gestión

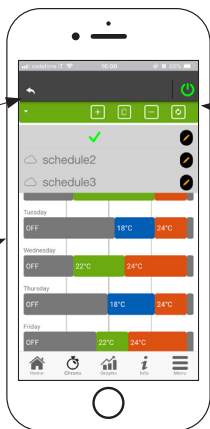
Franjas horarias creadas por el proceso



1. **Gestión del programa SMART FIRE:** El menú desplegable en la parte superior izquierda muestra los programas establecidos por el usuario. Seleccione la nube para habilitar el programa. Presione el símbolo  para cambiar los termostatos de cada franja;
2. **Agregar franja horaria:** Al seleccionar el botón  se puede desdoblarse un intervalo de tiempo, como se muestra en las imágenes:

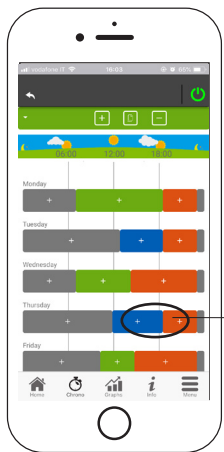

Al presionar el símbolo "+",  
divido la banda en dos,  
manteniendo la misma  
configuración de la banda inicial

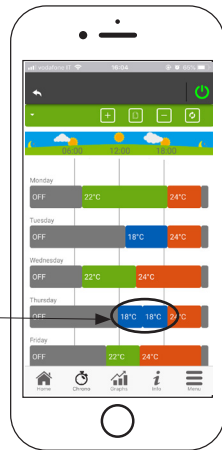



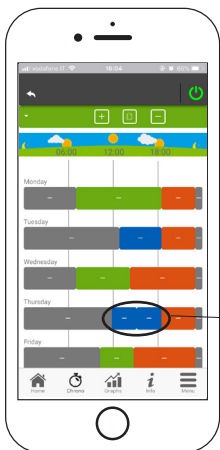

3. **Eliminación de la franja horaria:** al seleccionar el botón  e puede eliminar un intervalo de tiempo, como se muestra en las imágenes:

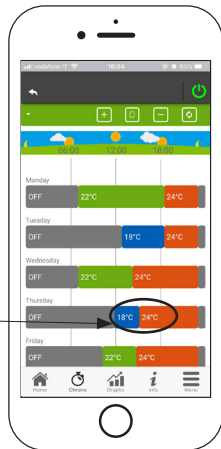

Al presionar el símbolo " - ", elimino el intervalo de tiempo deseado



4. **Actualiza los cambios:** A través del botón  el SMART FIRE se sincroniza con el dispositivo. Asegúrese de presionarlo cada vez que se realice un cambio.



5. **Copia de una franja horaria:** Al seleccionar el botón  puedo copiar las franjas horarias de un día a otro. Pulse la tecla de confirmación en la parte inferior de la página;
6. **Cambio de franja horaria:** Pulsando en una franja horaria se accede al menú de gestión, como se muestra en la imagen:

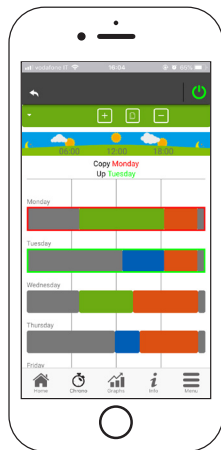
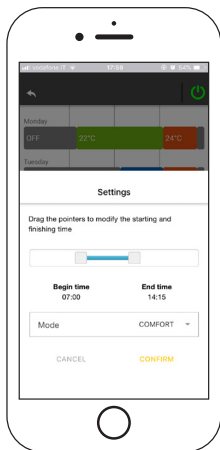



Esta sección muestra los gráficos de los valores registrados en el servidor por el SMARTFIREModule. Hay dos tipos de vistas disponibles:

1. **Diaria:** los valores visualizados se representan a lo largo del día de funcionamiento del sistema de calefacción. Se pueden visualizar dos franjas horarias: 00:00/12:00 o 12:00/00:00.
2. Además se puede también elegir mostrar los estados de funcionamiento del sistema de calefacción (por ejemplo Apagado, Normal, Bloqueo). Los datos grabados permanecen en la memoria semanalmente;
3. **Período:** representación gráfica de las horas de funcionamiento del sistema sobre base semanal. Los datos grabados permanecen en la memoria anualmente.

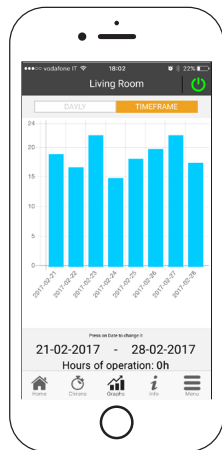
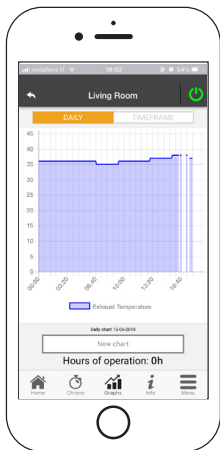

Esta pantalla muestra todos los valores registrados por la placa de control. Los valores por visualizar se pueden configurar a través del menú ajustes del módulo SMART FIRE seleccionado. "SETTING SMART FIRE" en la página 14

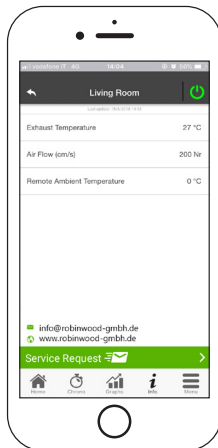

Además se pueden visualizar los datos de referencia del proveedor del servicio y enviar posibles solicitudes de asistencia por correo electrónico. En el caso de que la App esté personalizada para un cliente específico, será posible introducir sus datos de identificación.





En la pantalla Menú, puede acceder a:

- **Gestión de potencia:** en este menú es posible modificar la potencia de combustión y / o la potencia de calefacción;
- **Gestión del termostato:** permite cambiar el termostato principal y otros termostatos si así lo requieren las funciones del sistema de calefacción.



FRANÇAIS

ARCHITECTURE DU SYSTEME	2
CONNEXION LOCALE ET CONNEXION A DISTANCE	3
CARACTERISTIQUES TECHNIQUES	4
BOUTONS ET VOYANTS	5
INSTALLATION	6
CONFIGURATON D'UN NOUVEAU SMARTFIREModule	7
CONNEXION A UN SMARTFIREModule DEJA CONFIGURE	10
PAGE D'ACCEUIL	11
PARAMETRES SMART FIRE	14
GESTION SMART FIRE	15
FONCTIONNALITE CHRONO ET SMART FIRE	16
VISUALISATION GRAPHIQUE	21
ECRAN INFO	22
ECRAN MENU	23

L'architecture se présente en 3 macros-système:

1. **SMARTFIREModule:** Périphérique matériel assurant l'interface entre la carte de commande électronique du poêle et le routeur WI-FI local;
2. **SERVER CLOUD:** infrastructure de serveur Web qui permet le stockage de données et joue le rôle de centre étoile dans la communication à distance;
3. **SMART FIRE:** application par smartphone disponible sur Google Play et sur AppStore gratuitement, ce qui à l'utilisateur de connecté à son système de chauffage.

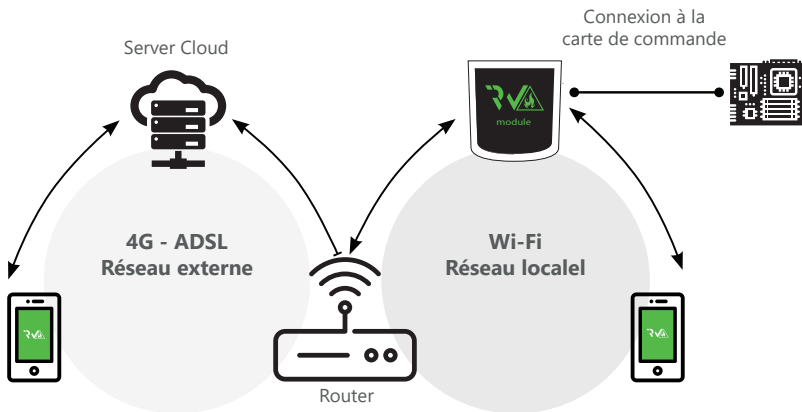



## Connexion Locale

La connexion entre le module et l'application s'effectue par l'intermédiaire du réseau domestique WI-FI uniquement si les deux appareils sont connectés au même réseau WI-FI.

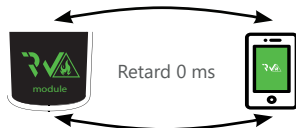

## Connexion à distance

On parle de connexion à distance quand, au moment de l'utilisation de l'application, l'utilisateur est absent. Dans ce cas, l'application tire parti de la couverture de données de votre smartphone et du Serveur Cloud permettant la triangulation du signal et de gérer le module à distance.

Les temps de connexion peuvent varier en fonction du trafic sur le réseau de données, des conditions de connexion au réseau et du trafic sur le serveur. Dans le pire des cas, les temps de connexion peuvent être 5 minutes en retard.

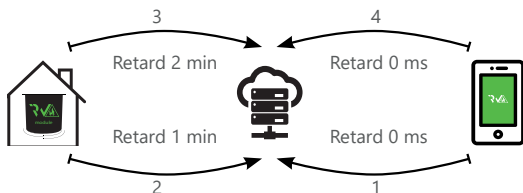

Le mode de connexion à distance n'est utilisable que si l'utilisateur s'est déjà enregistré auprès du serveur Cloud, voir le paragraphe: "CONFIGURATON D'UN NOUVEAU SMARTFIREModule" à la page 9



## CARACTERISTIQUES TECHNIQUES

Port de communication	RS232 RS485
Alimentation	5V
Boîtier	Boîtier en ABS
Plage de température	-20° ÷ 60°
Fixation	Vis auto-taraudeuse de 3,5 mm

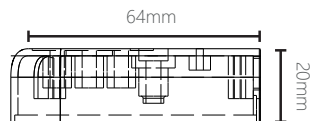
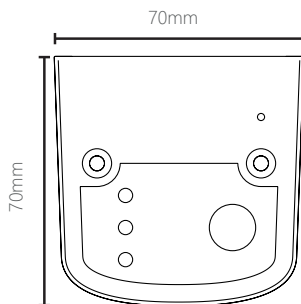

SMART FIRE garanti le fonctionnement de l'appareil uniquement avec les câbles fournis.

(d) Bouton de réinitialisation Boîtier

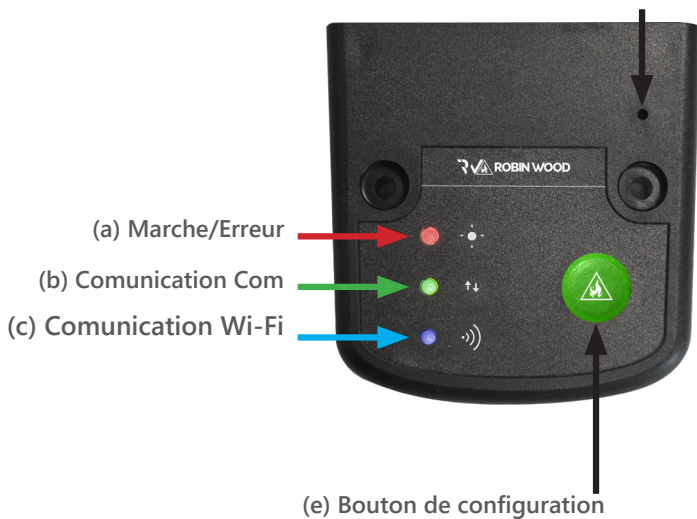



1. **Connecter le SMARTFIREModule à l'alimentation:** Le voyant (a) doit être allumé et ne pas clignoter;
2. **Connecter le SAMRTFIREModule à la carte de ROBIN WOOD à l'aide du câble fourni dans le kit:** Le voyant (b) doit être allumé et non clignoter. En cas de clignotement, il peut y avoir des problèmes de communication avec la carte de contrôle, s'assurer que le système de chauffage est branché au secteur;
3. **Communication Wi-Fi:** le voyant (c) fixe, la connexion avec l'application SMART FIRE a été établie et l'appareil communique correctement;
4. **Bouton de réinitialisation boîtier (d):** Appuyer en cas de dysfonctionnement persistant de l'appareil.

<b>MARCHE</b>	Clignotant	Status: Erreur
	Fixe	Status: OK
<b>COM</b>	Clignotant	Pas de communication avec la carte de contrôle
	Fixe	Communication effectuée
<b>Wi-Fi</b>	Clignotant	Connexion Wi-Fi non configurée
	Fixe	Wi-Fi Connecté
<b>POWER/ Wi-Fi</b>	Clignotant	Phase de configuration



Si l'appareil est hors ligne pendant le fonctionnement normal, appuyez sur le bouton  pendant 3 secondes. Pendant la configuration et le fonctionnement, les voyants peuvent changer de fixe à clignotant.





Nous vous recommandons de connecter immédiatement votre smartphone au réseau Wi-Fi domestique. Lors du démarrage de l'application vous êtes invité à sélectionner la langue.

La procédure de configuration du SMARTFIREModule est expliquée ci-dessous:

1. Créer un compte avec une adresse email valide et un mot de passe au choix.
2. Choisir "Ajouter SMART FIRE" et "Trouver un appareil". Dans le cas d'un premier démarrage du SMART FIRE, il faut sélectionner "Ajouter SMART FIRE".

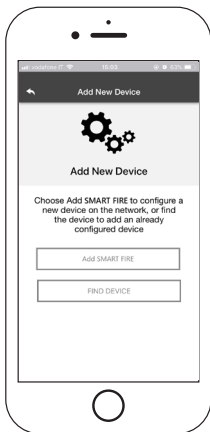



## CONFIGURATON D'UN NOUVEAU SMARTFIREModule

1. Suivre la procédure guidée. Le SMARTFIREModule crée un réseau Wi-Fi temporaire auquel vous devez vous connecter avec le Smartphone. De cette façon, le module sera connecté à l'application et au compte associé;
2. Une fois l'application et le SMARTFIREModule connectés, il est demandé de choisir le réseau Wi-Fi domestique auquel le SMARTFIREModule doit se connecter;
3. Donner un nom à l'appareil et entrer un code PIN de votre choix. Chaque appareil du SMARTFIREModule a son propre nom et mot de passe.

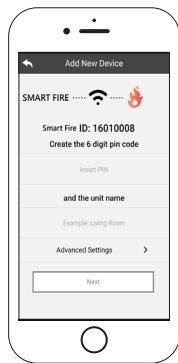

Si la procédure de configuration a échoué, reconfigurer le SMARTFIREModule en maintenant la touche  enfoncée pendant 8 secondes.



Une fois l'installation du SMARTFIREModule terminée, il est conseillé de fermer l'application et de la redémarrer.



Fermer l'application entre les fenêtres ouvertes en arrière-plan.

### Sur les appareils Apple:

- Appuyer deux fois sur la touche Accueil;
- Faire glisser vers la gauche l'aperçu de l'application SMART FIRE pour la fermer.

### Sur les appareils Android:

- Appuyer sur la touche en bas à droite pour les appareils avec touches tactiles ou sur la touche en bas à gauche pour les appareils avec touches physiques;
- Faire glisser vers la gauche l'aperçu de l'application SMART FIRE pour la fermer.

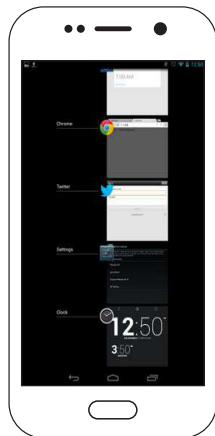
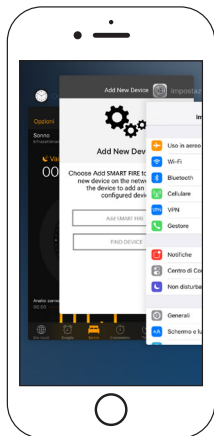



## CONNEXION A UN SMARTFIREModule DEJA CONFIGURE

Dans la session "Trouver un appareil", vous pouvez vous connecter à un SMARTFIREModule en entrant le code PIN à la condition que le SMARTFIREModule est connecté au même réseau Wi-Fi que le Smartphone.



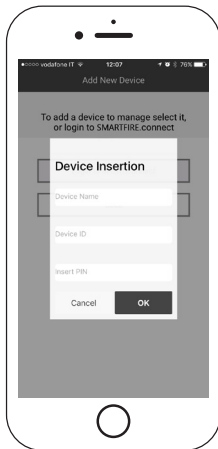

Il est également possible de se connecter à distance (à l'aide de la connexion donnée mobile de votre smartphone) en saisissant les informations d'identification d'accès du boîtier SMART FIRE déjà configuré.





La liste des appareils connectés est affichée sur la page d'accueil avec pour indication la température et l'état de fonctionnement de chaque appareil.

Les appareils SMART FIRE associés apparaissent sur l'écran d'accueil avec leur nom d'identification. Information état:

-  Status fonctionnement ARRÊT
-  Status fonctionnement BLOQUE
-  Status fonctionnement en Allumé
-  Appareil non connecté ou inaccessible
-  Mise à jour nécessaire

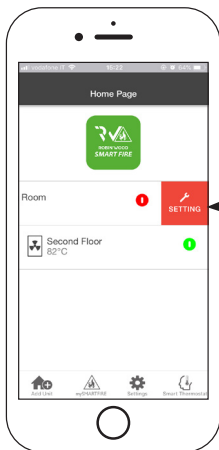

Accès aux paramètres de l'appareil SMART FIRE.  
Se référer au chapitre "PARAMETRES SMART FIRE" à la page 16.



Add Unit

Ce menu permet de configurer un autre appareil SMART FIRE.  
"CONFIGURATON D'UN NOUVEAU SMARTFIREModule" à la page 9.



Le menu **mySMARTFIRE** répertorie les informations d'identification del'appareil associées à votre application.

Grâce à l'icône  il est possible d'en voyer, via des services de messagerie électronique et messagerie, les données aux applications SMART FIRE à d'autres utilisateurs, permettant ainsi le partage de la gestion du système de chauffage.



Settings

- **Gestion des comptes:** menu qui permet de créer un nouveau compte ou se connecter/déconnecter;
- **Restaurer App:** permet de réinitialiser l'application à la configuration par défaut;
- **Réactiver le didacticiel:** permet de réactiver le tutoriel d'utilisation de l'application;
- **Gestion des notifications:** permet d'activer les notifications sur l'état du système de chauffage;
- **Langue:** permet de sélectionner la langue;
- **Info App:** Permet de visualiser les informations sur la version de l'application smartphone installée;
- **Téléchargement des instructions:** Permet de télécharger le manuel d'utilisation expliquant l'utilisation de l'application. Appuyer sur l'icône de sauvegarde pour enregistrer le manuel dans la mémoire interne du smartphone.

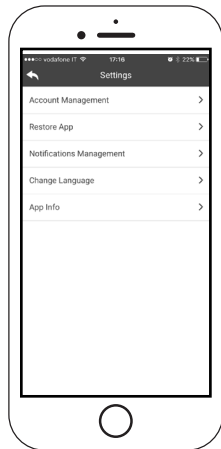



Permet de se connecter aux applications de gestion des thermostats installés dans votre système domestique. Pour se connecter au thermostat intelligent, saisir les informations d'identification des comptes enregistrés lors de la configuration de celui-ci.

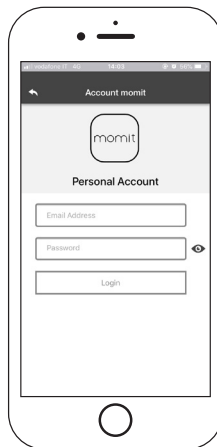
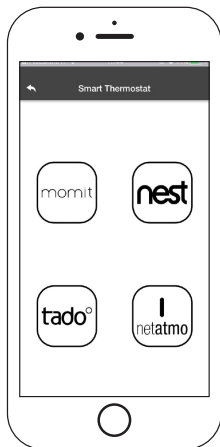



Accès aux paramètres de configuration du SMARTFIREModule sélectionné.

- **Nom de l'appareil:** possibilité de changer le nom actuel de l'appareil;
- **Icône Appareil:** changer l'icône d'affichage du module sur l'écran d'accueil;
- **Activation de l'assistance à distance:** l'utilisateur autorise la possibilité de recevoir une assistance technique à distance;
- **Widget:** Permet de sélectionner les Widgets qui apparaissent sur l'écran principal de gestion des appareils;
- **Paramètres du menu:** permet de personnaliser l'affichage des fonctions du menu. Certaines fonctions ne peuvent pas être disponibles en raison de la configuration du système de chauffage. "ECRAN MENU" à la page 25;
- **Info sur les paramètres:** permet de personnaliser l'affichage des valeurs système du menu d'information. Voir "ECRAN INFO" à la page 24;
- **Retirer l'appareil:** permet de supprimer l'appareil actuellement sélectionné;
- **Modification Météo:** la météo locale, qui apparaît sous forme de widget, peut être réglée manuellement en saisissant les coordonnées de latitude et de longitude souhaitées ou en utilisant le GPS de votre smartphone;
- **Info:** informations techniques concernant le code produit de la carte de contrôle et la version du firmware du module;
- **Info Wi-Fi:** information sur le réseau auquel le SMARTFIREModule est connecté.

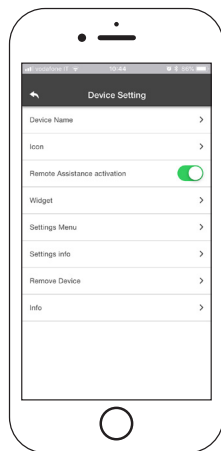







## Status de fonctionnement:

affiche l'état dans lequel est le système ainsi que les erreurs éventuelles.

## Thermostat principal:

visualisation du thermostat du système.

Maintenir  enfoncé la modification du thermostat est active.

Appuyer sur les touches  et  ou effectuer un mouvement de doigt sur la bande, la température ambiante varie.

## Widget:

affiche des informations relatives à l'opération. Vous pouvez choisir les widgets à afficher sur l'écran principal via le menu .

## Système ALLUME:

appuyer pour éteindre

## Système ETEINT:

appuyer pour allumer

## Synchronisation:

 clignotant indique que l'application et le module échangent des informations. A la fin, le résultat du changement est reconnu.

## Température Principale

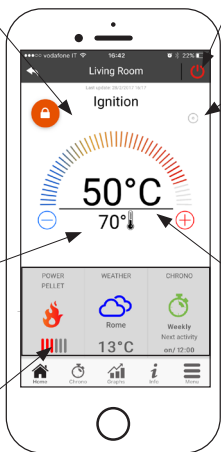



En accédant au menu Chrono, vous pouvez définir la fonction de gestion du système dans deux modes différents.

Appuyer sur  pour accéder à la modification de la fonction souhaitée.

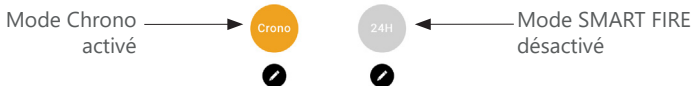

En entrant dans la fonction **CHRONO**, vous pouvez définir 3 créneaux horaires différents pour allumer et éteindre le système de chauffage.

Vous pouvez choisir trois types de programmation:

- Semaine: réglage du lundi au dimanche;
- Journalier: réglage chaque jour;
- Weekend: réglage du week-end (samedi et Dimanche) ou en semaine (du lundi au vendredi).

Chaque fois que cette fonction est mise à jour, appuyez sur le bouton Enregistrer qui apparaît en bas de l'écran. Pour réinitialiser le créneau horaire, utilisez le panier qui apparaît avec la touche à glissière à droite du créneau horaire.

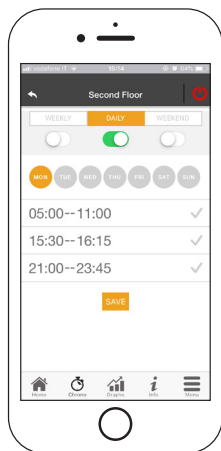





La fonction **SMART FIRE** permet, via une procédure guidée, de gérer le chauffage domestique, de régler les heures et les températures en fonction des besoins quotidiens. Au cours de l'assistant, quelques questions simples de la routine quotidienne sont posées, à l'aide desquelles le programme SMART FIRE définit le programme hebdomadaire. La possibilité de choisir le thermostat pour les trois bandes disponibles est donnée.

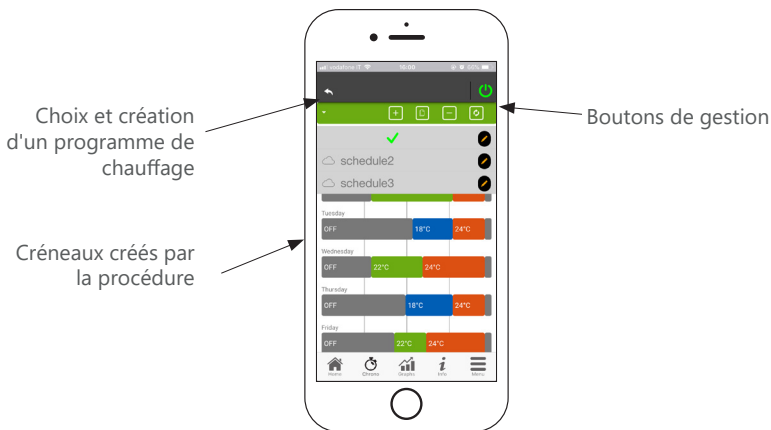

SMART FIRE vous permet de gérer les créneaux horaires également à partir de l'écran principal:





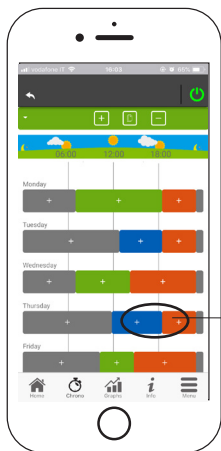

1. **Gestion des programmes SMART FIRE:** le menu déroulant en haut à gauche affiche les programmes définis par l'utilisateur. Sélectionnez la bulle pour activer le programme. Appuyer sur le symbole  pour changer les thermostats de chaque bande
2. **Ajouter d'une plage horaire:** en sélectionnant le bouton  vous pouvez diviser un groupe horaire, comme le montrent les images:

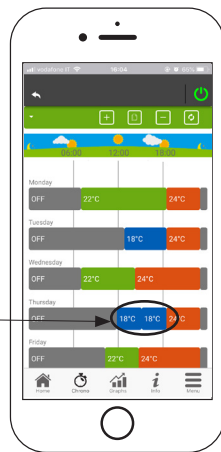

Appuyer sur le symbole "+"  
divise la bande en deux,  
en conservant les mêmes  
paramètres que le  
point de départ





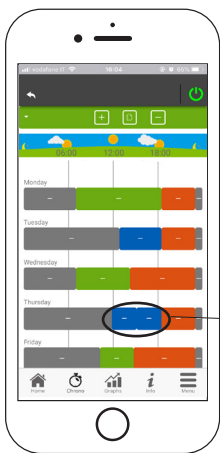

3. **Suppression des plages horaires:** en sélectionnant le bouton  une plage horaire peut être supprimée, comme indiqué dans les images:

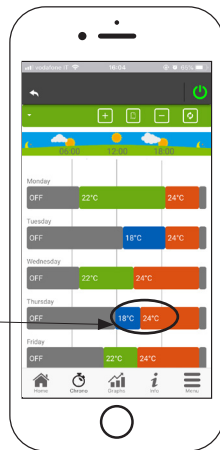

Appuyer sur le symbole  
"-", la plage  
horaire souhaitée est  
supprimée



4. Mettre à jour les modifications: en appuyant sur le bouton  **SMART FIRE** est synchronisé avec l'appareil. Veillez à appuyer sur synchronisé chaque fois qu'un changement est effectué.



1. **Copier une plage horaire:** sélectionner le bouton  possibilité de copier la plage horaire du jour au lendemain. Lorsque vous avez terminé, appuyer sur le bouton de confirmation en bas de la page.
2. **Changement de la plage horaire:** appuyez sur une plage horaire pour accéder au menu de gestion, comme indiqué par l'image:

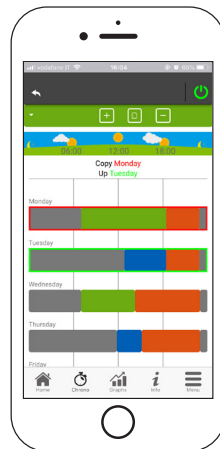
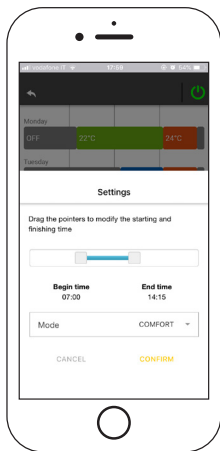

Cette section présente les graphiques des valeurs enregistrées sur le serveur par le SMARTFIREModule. Il existe deux types de vues disponibles:

1. **Journalier:** les valeurs affichées sont représentées pendant la journée de fonctionnement du système de chauffage. Vous pouvez afficher les graphiques de deux plages horaires: 00: 00/12: 00 ou 12: 00/00: 00. Vous pouvez également choisir d'afficher l'état de fonctionnement du système de chauffage (par exemple, Arrêt / Normal / Bloc, etc.). Les données enregistrées restent en mémoire toutes les semaines.
2. **Période:** représentation graphique des heures de fonctionnement du système sur une base hebdomadaire. Les données enregistrées restent en mémoire chaque année.

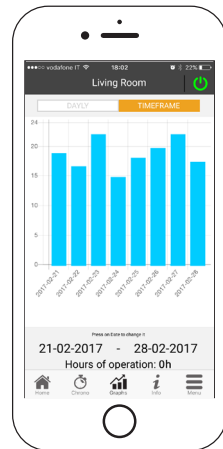
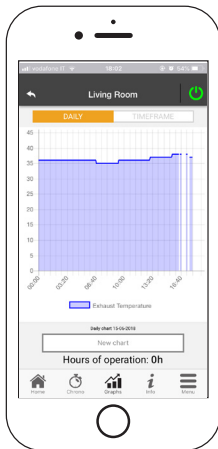

Cet écran affiche toutes les quantités enregistrées par le tableau de commande. Les quantités à afficher peuvent être définies via le menu Réglages du périphérique SMARTFIREModule sélectionné. "PARAMETRES SMART FIRE" à la page 16

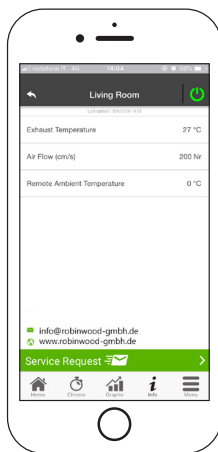

Il est également possible de consulter les données de référence du fournisseur de services et d'envoyer toute demande d'assistance par courrier électronique. Si l'application est personnalisée pour un client spécifique, toute donnée d'identification peut être introduite.



Sur l'écran Menu, vous pouvez accéder à:

- **Gestion de l'énergie:** dans ce menu, il est possible de modifier la puissance de combustion et / ou toute puissance de chauffage;
- **Gestion du thermostat:** permet de changer le thermostat principal et tout autre thermostat si les caractéristiques du système de chauffage l'exigent.





**ROBIN WOOD GmbH**

Überaucher Straße 9  
78052 Villingen-Schwenningen

+49 7705 9769692

+49 174 1799951

[info@robinwood-gmbh.de](mailto:info@robinwood-gmbh.de)

[www.robinwood-gmbh.de](http://www.robinwood-gmbh.de)